

W KRAINIE KOŁORÓW

Zestaw kolorowanek z pakietu aplikacji
dla podłogi interaktywnej

SMART FLOOR



Spis treści

3 latek rysuje.....	3
3 latki rysują razem.....	14
6 latek rysuje.....	25
6 latki rysują razem.....	36
Wyobraź sobie.....	47



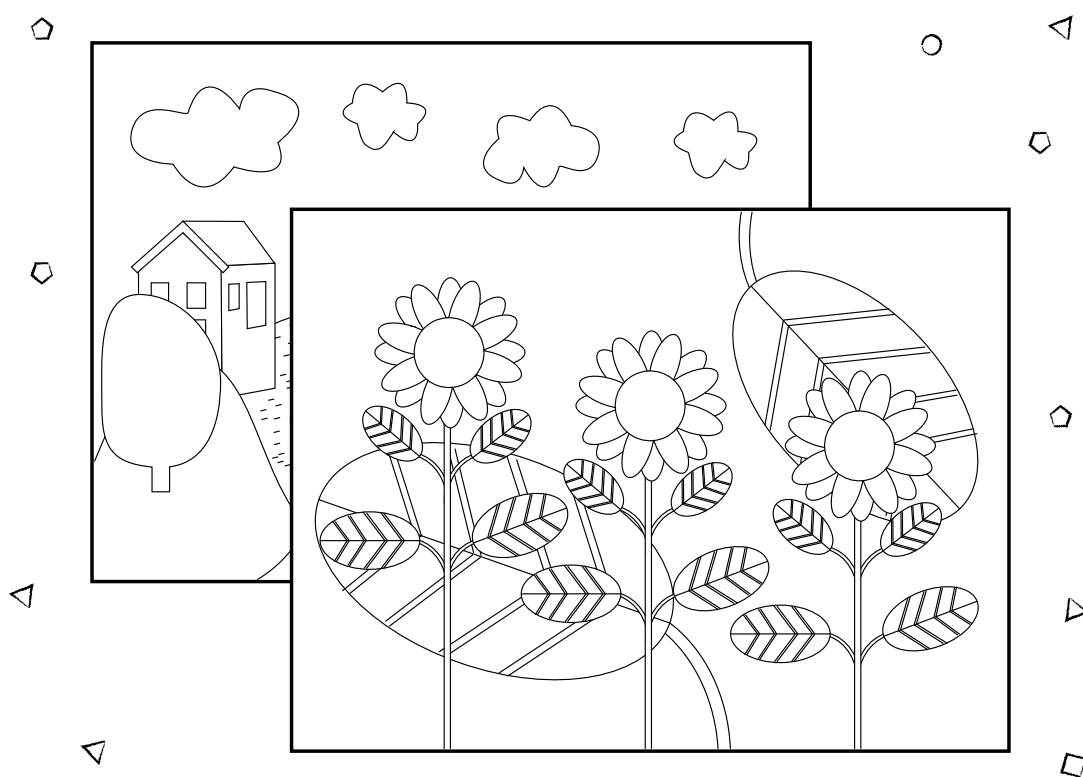

W KRAINIE KOLORÓW

3 latek rysuje

Narysuj drogę myszki do sera. Pokoloruj mysz i ser.

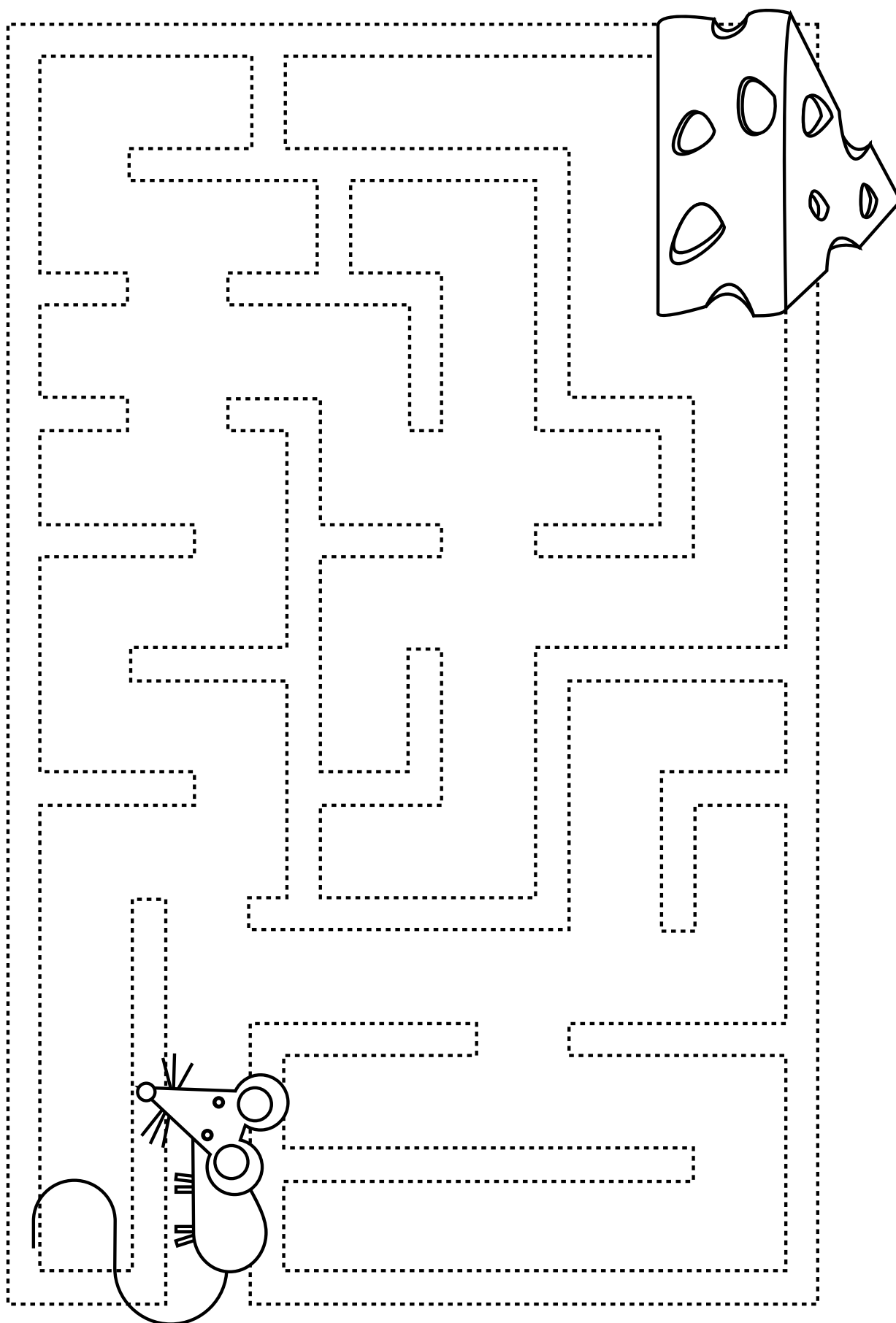

Pokoloruj kwiaty na łące.

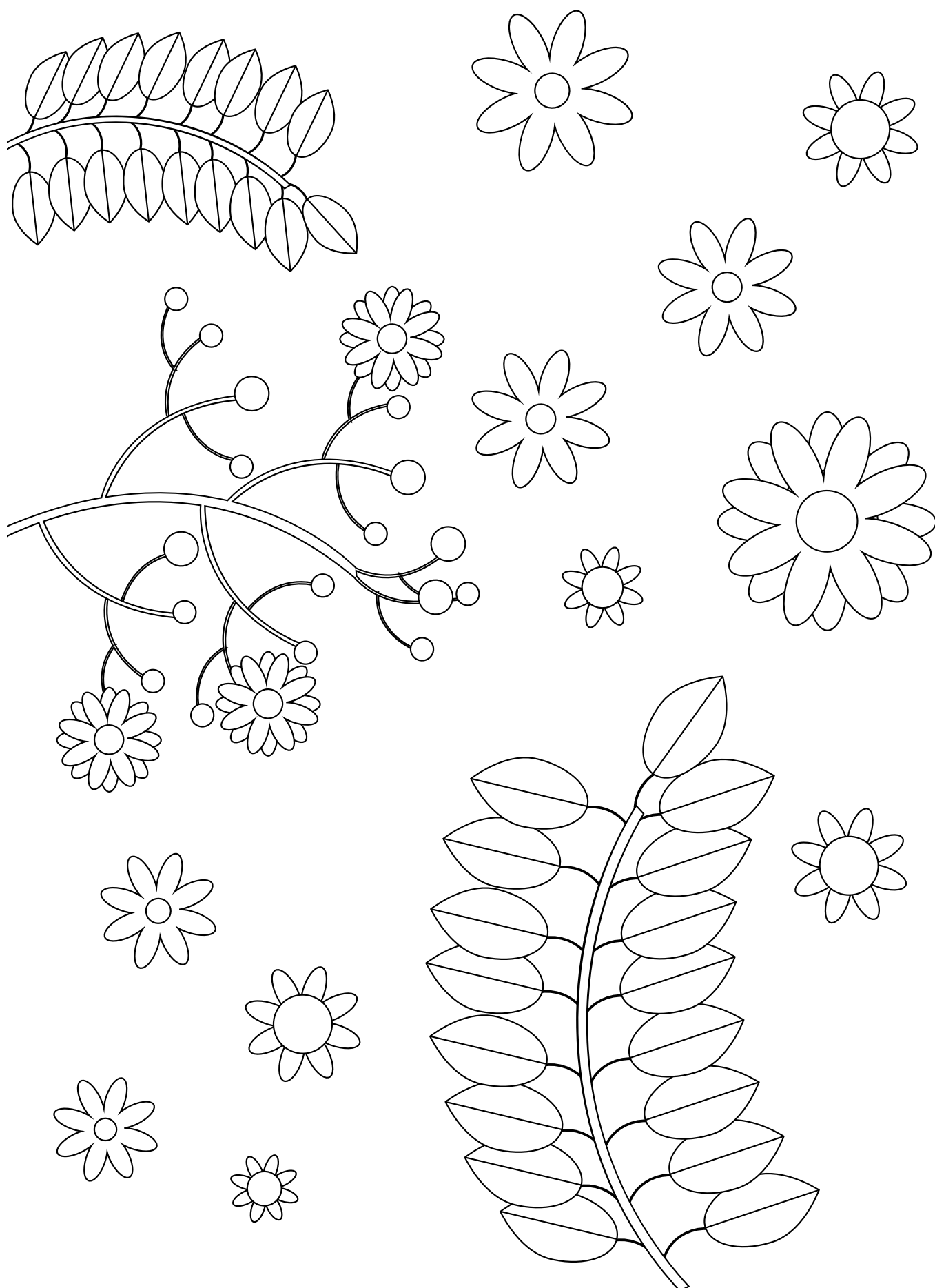

Pokoloruj obrazek. Narysuj kawałki tortu na talerzach dla gości.

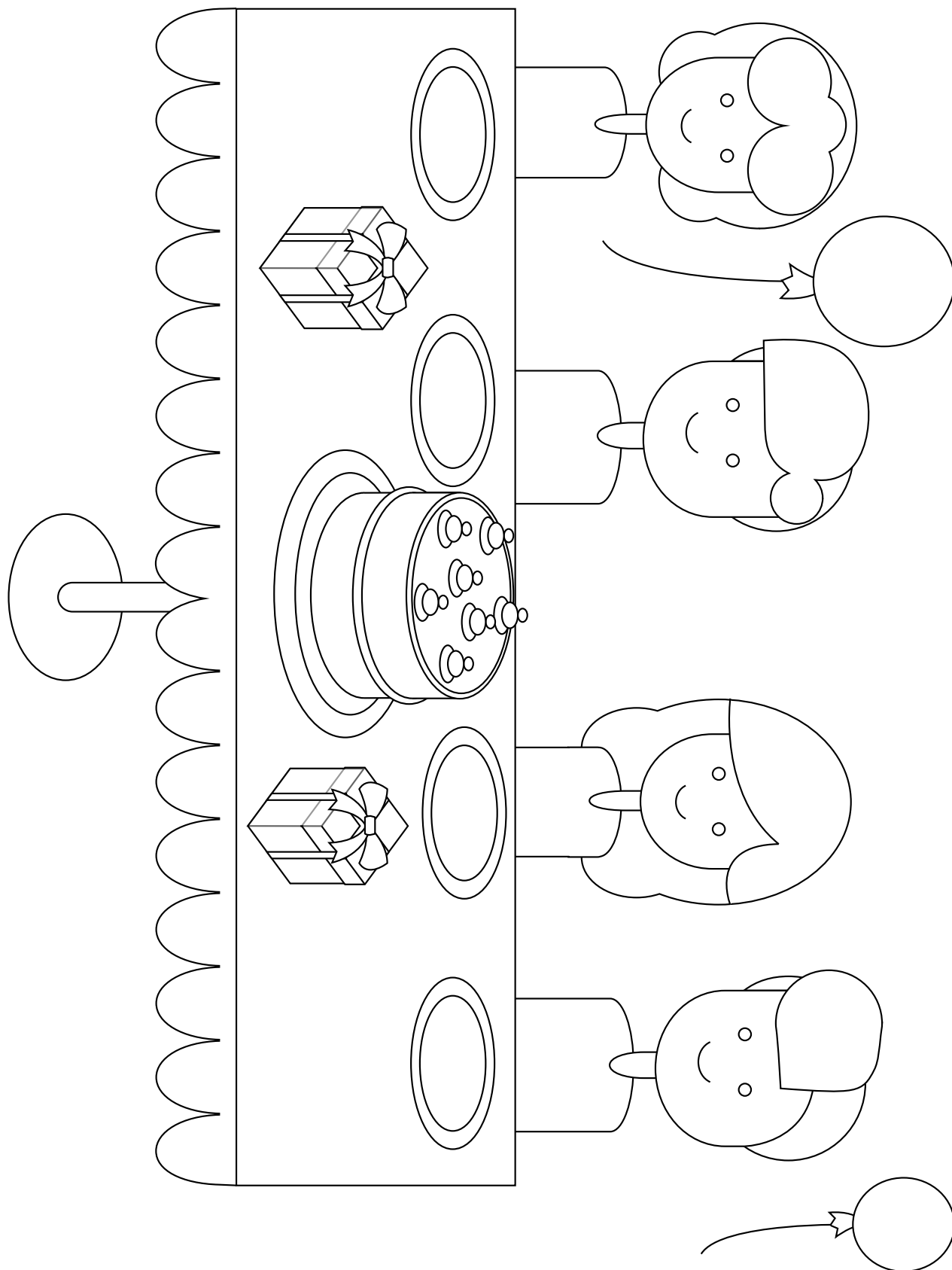

Pokoloruj podwodny świat.

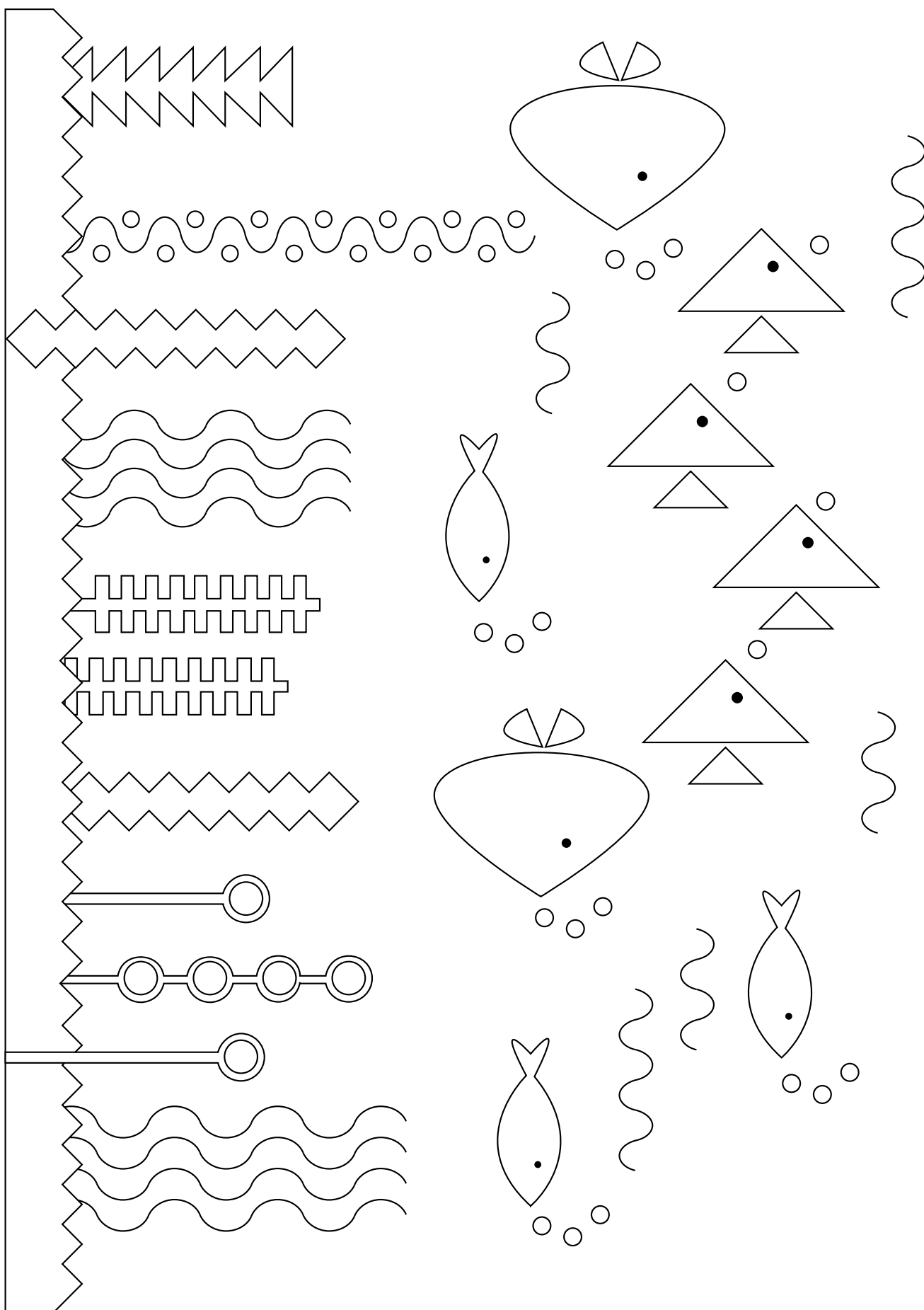

Pokoloruj obrazek. Dorysuj kominy na dachach domów.

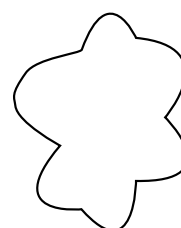
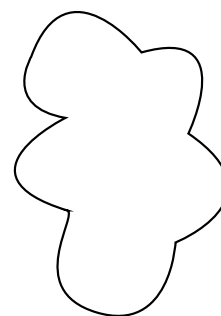
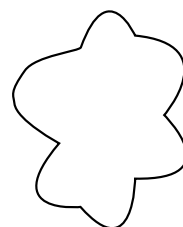
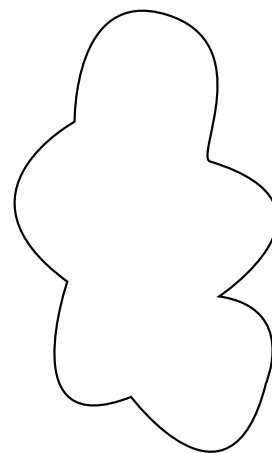
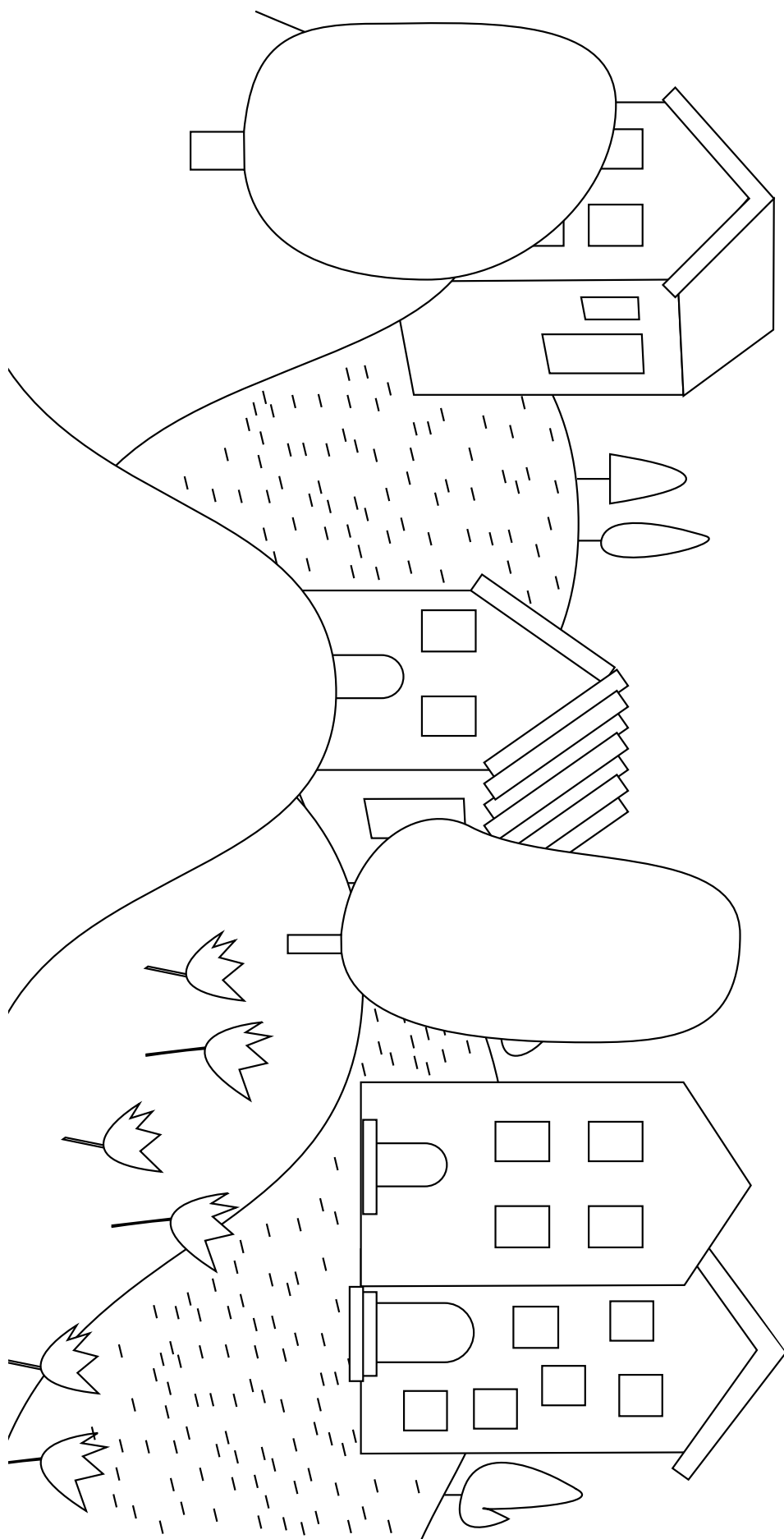

Pokoloruj balon.

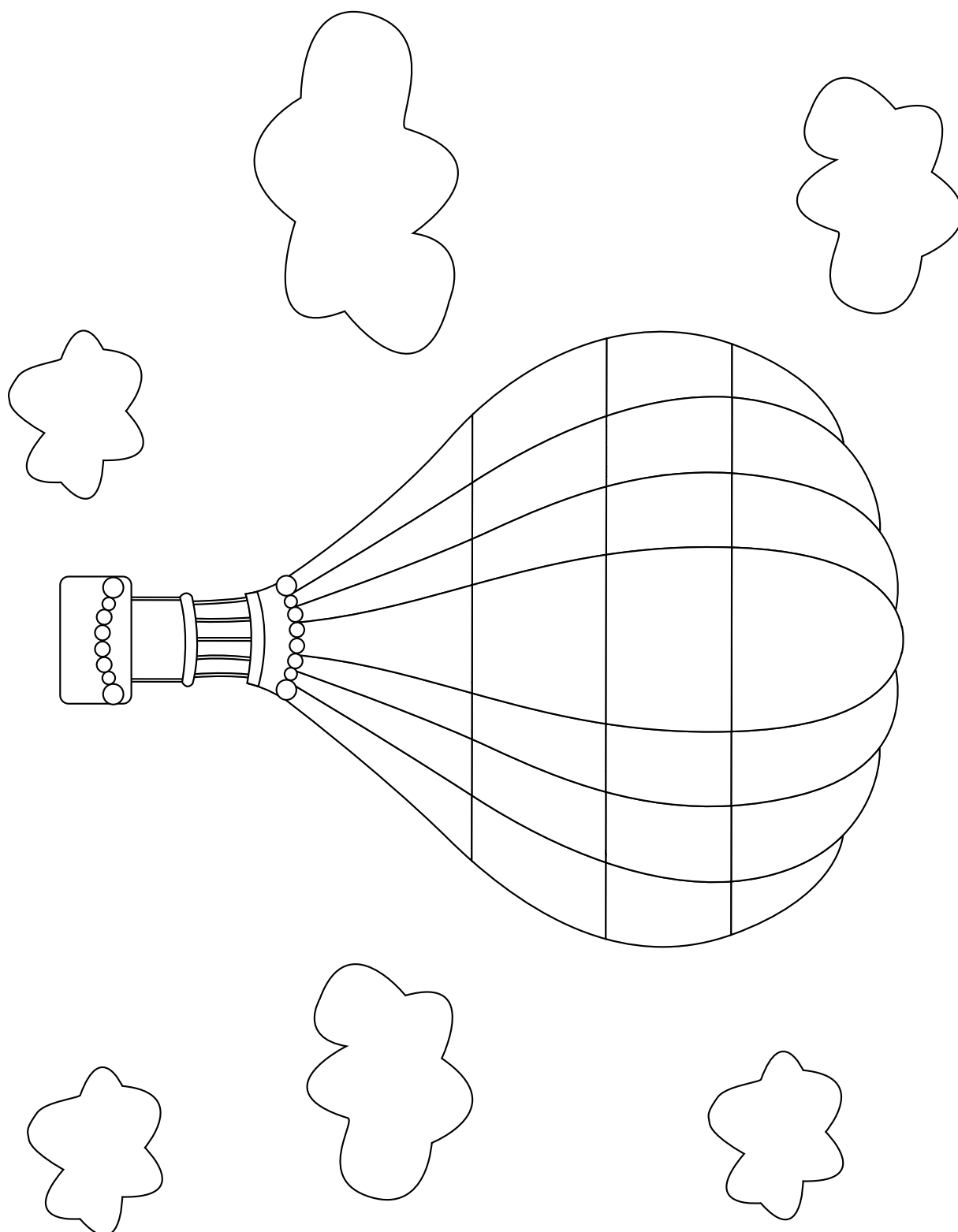

Pola oznaczone trójkątem pokoloruj na żółto. Co przedstawia rysunek?

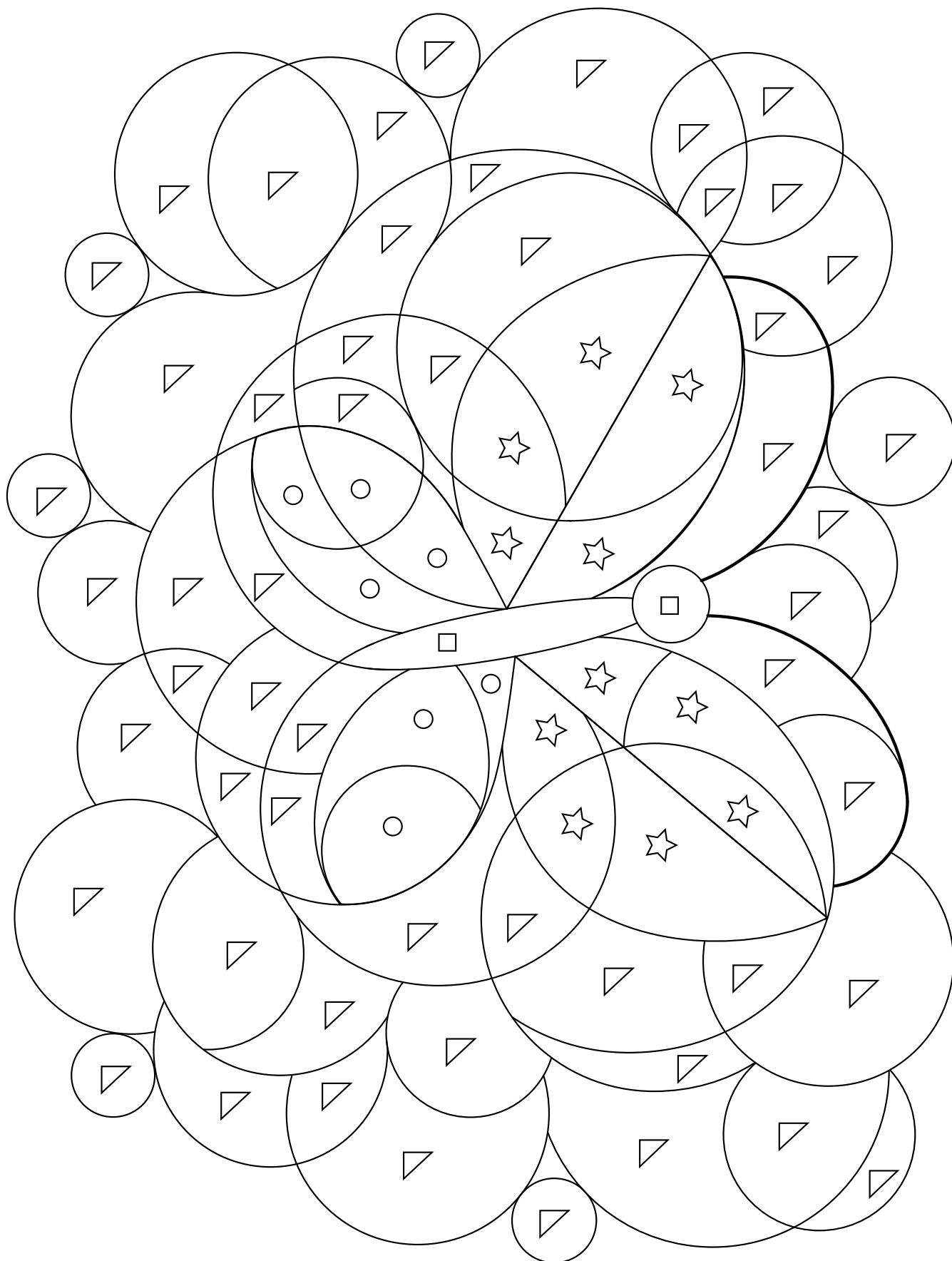

Pokoloruj auta. Dorysuj pasażerów.

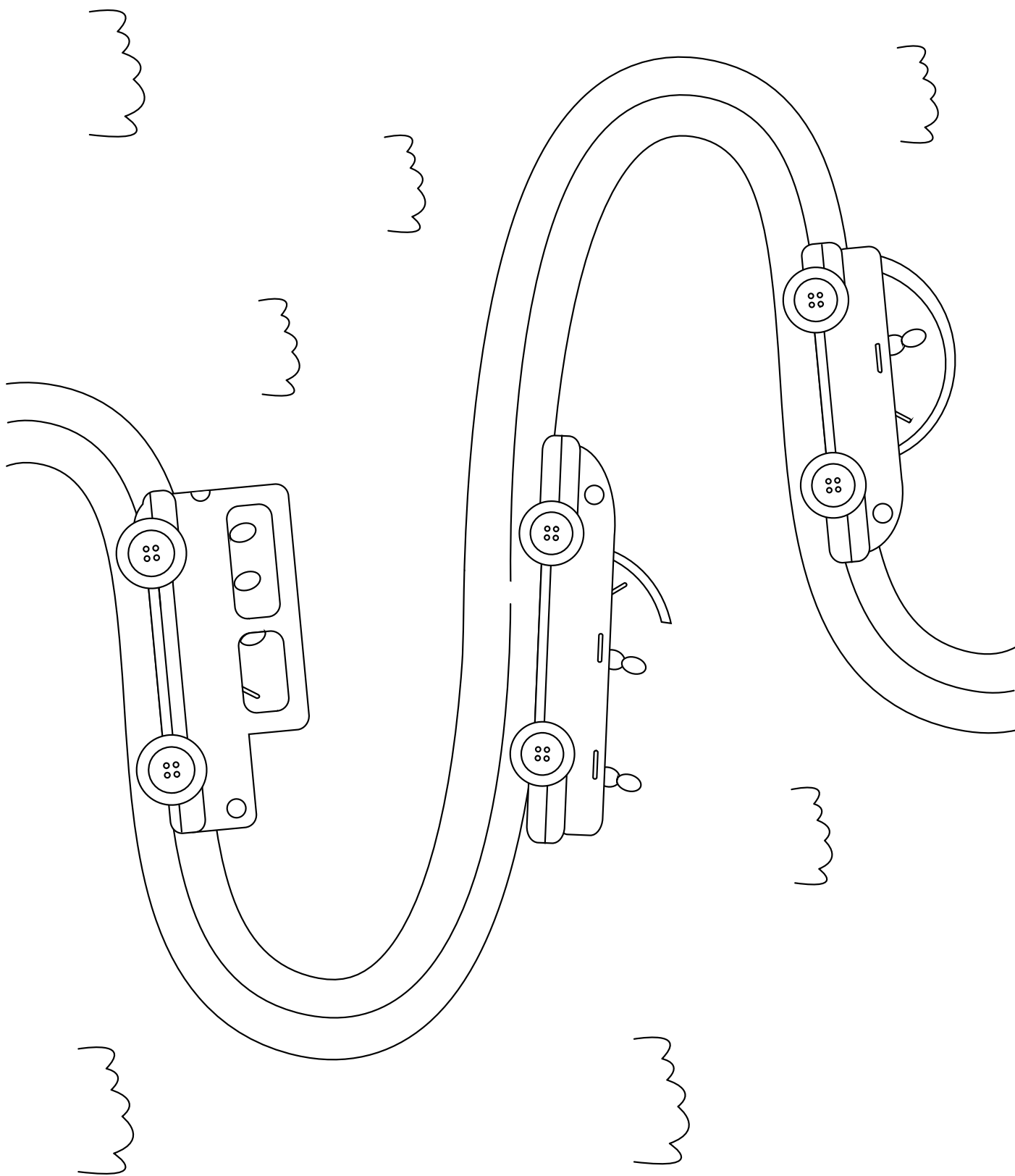

Pokoloruj rysunek. Dorysuj jeszcze jeden samolot.

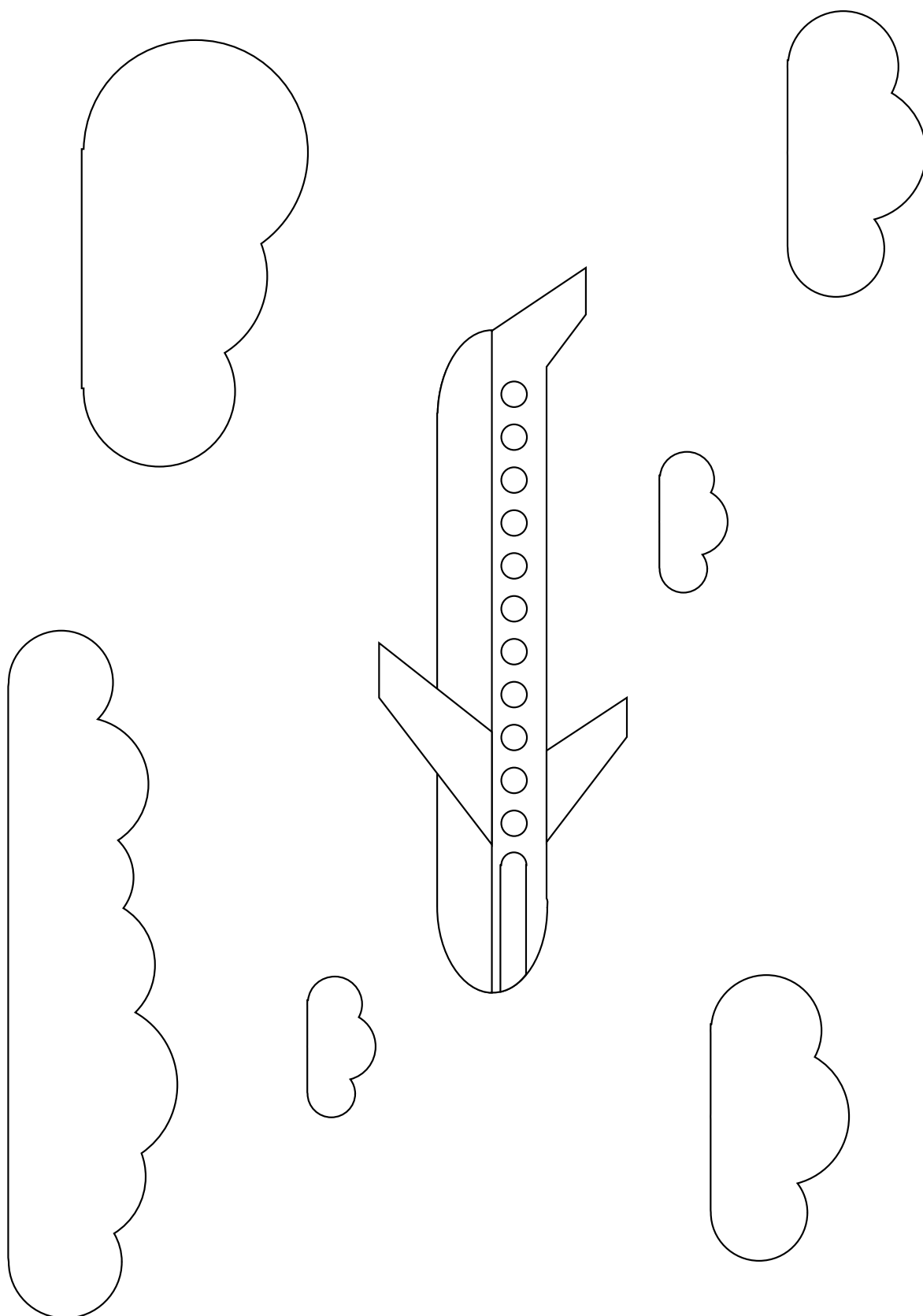

Pokoloruj królowy. Wymyśl dla nich imiona.

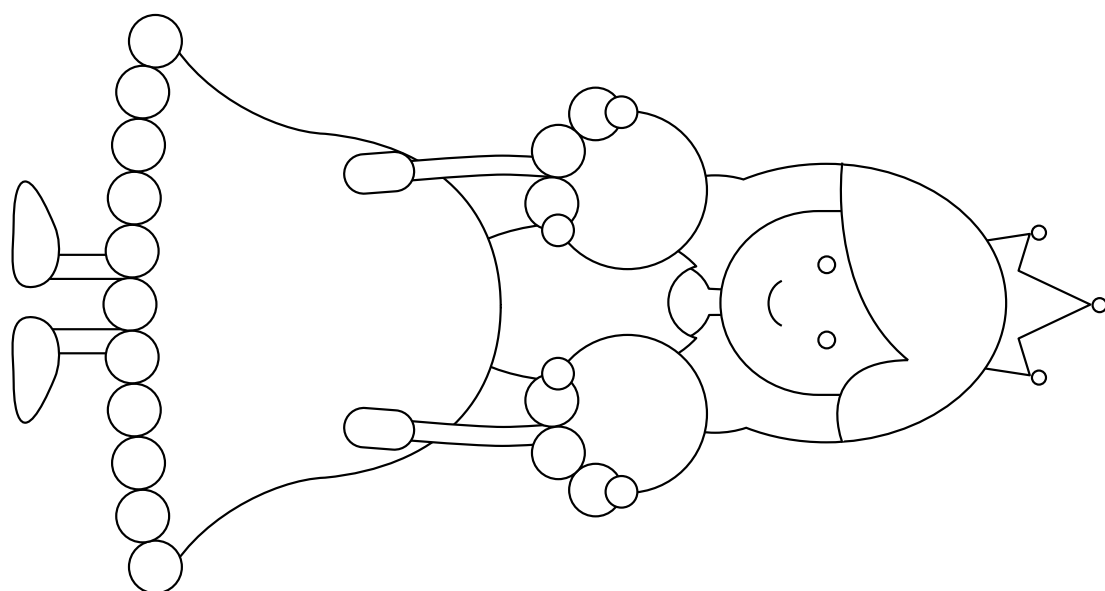
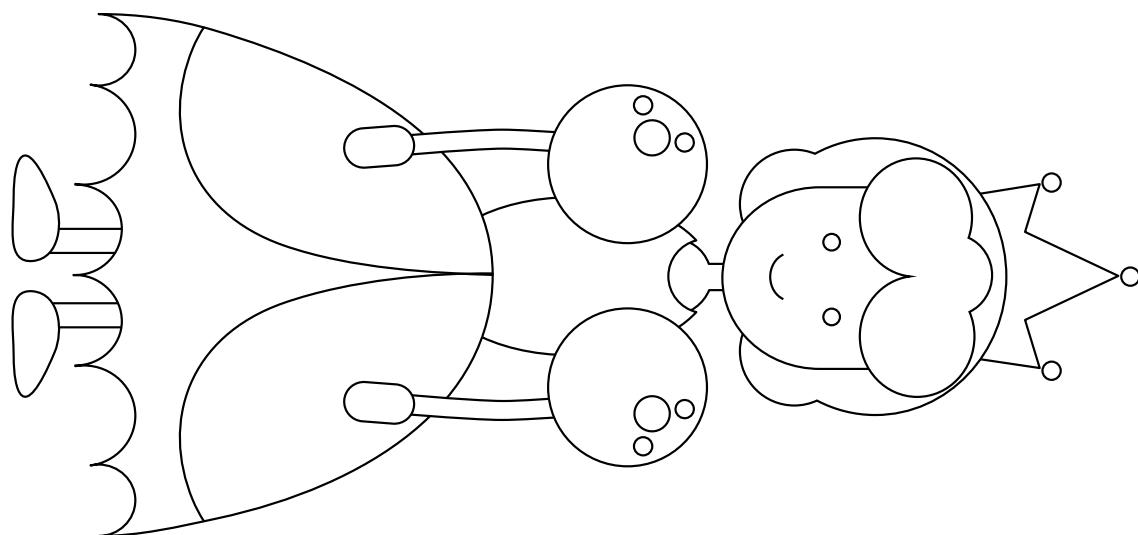

Połącz buty w pary, a następnie odpowiednio je pokoloruj.

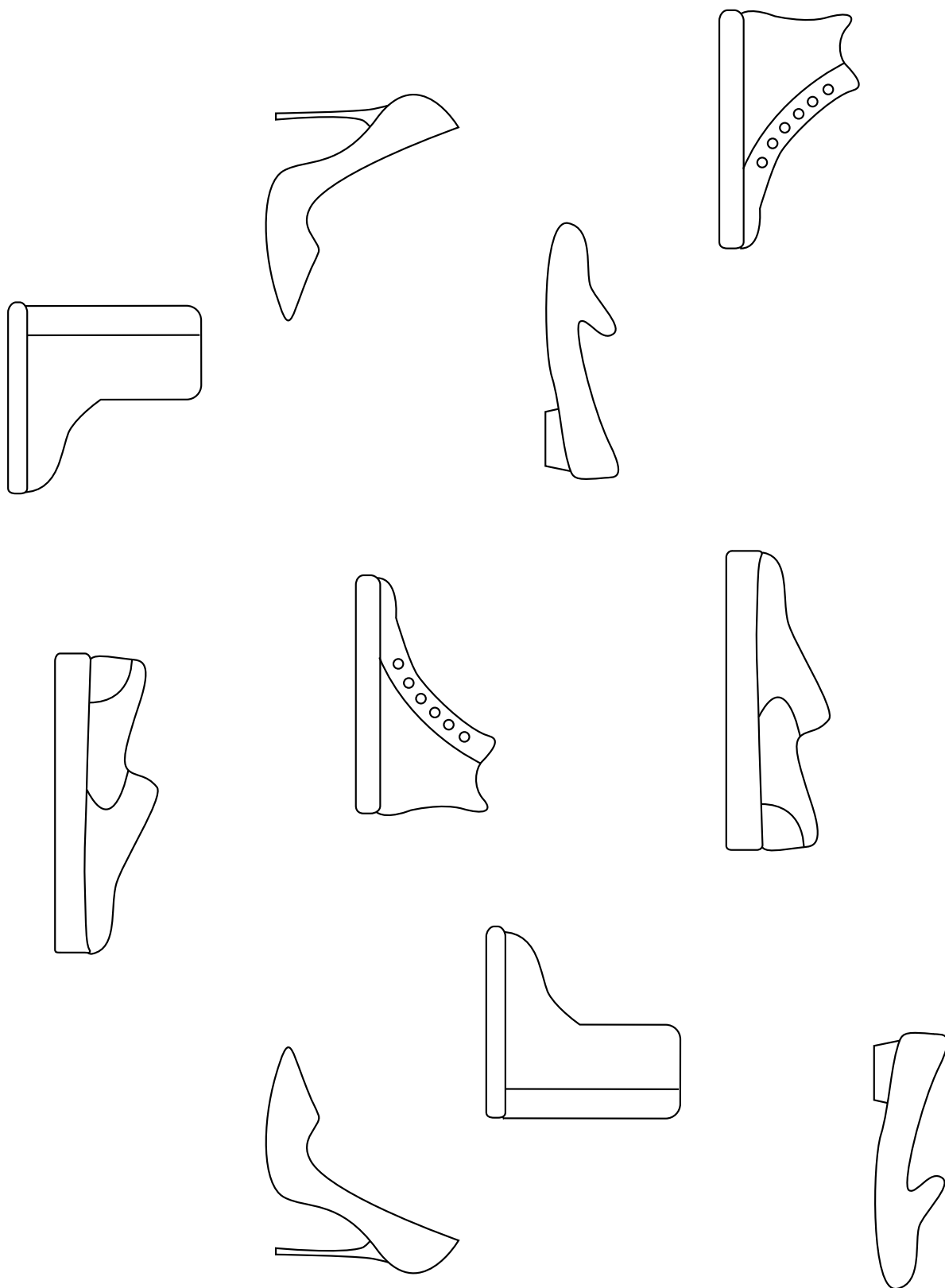

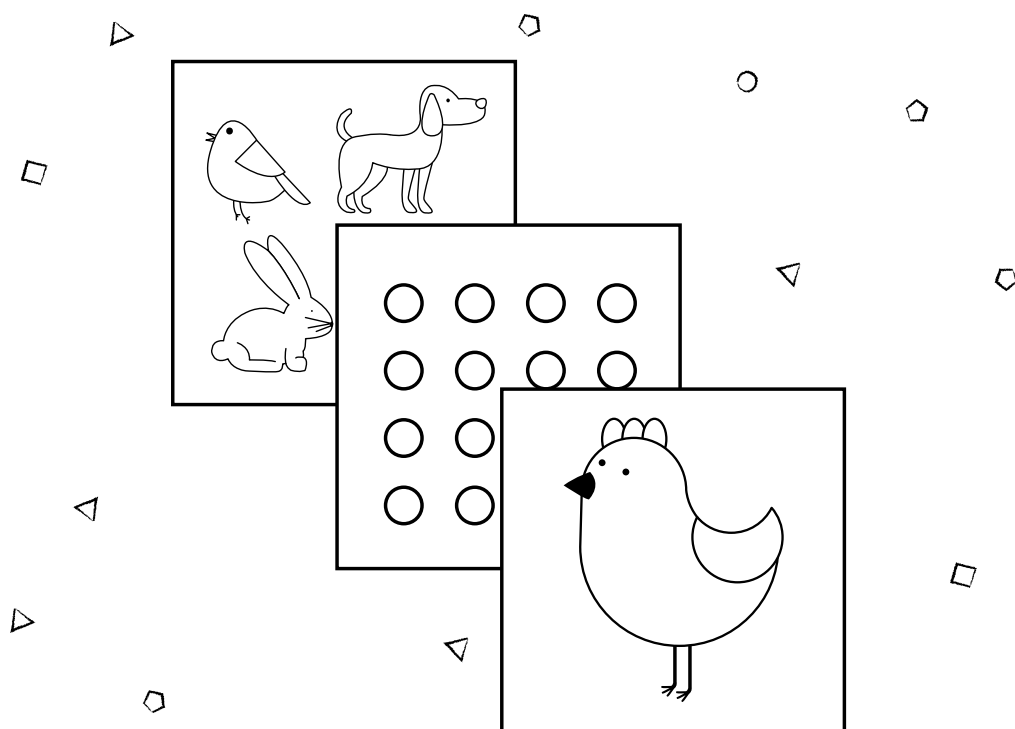

W KRAINIE KOLORÓW

3 latki rysują razem

Obrysuj królika po śladzie i pokoloruj go.

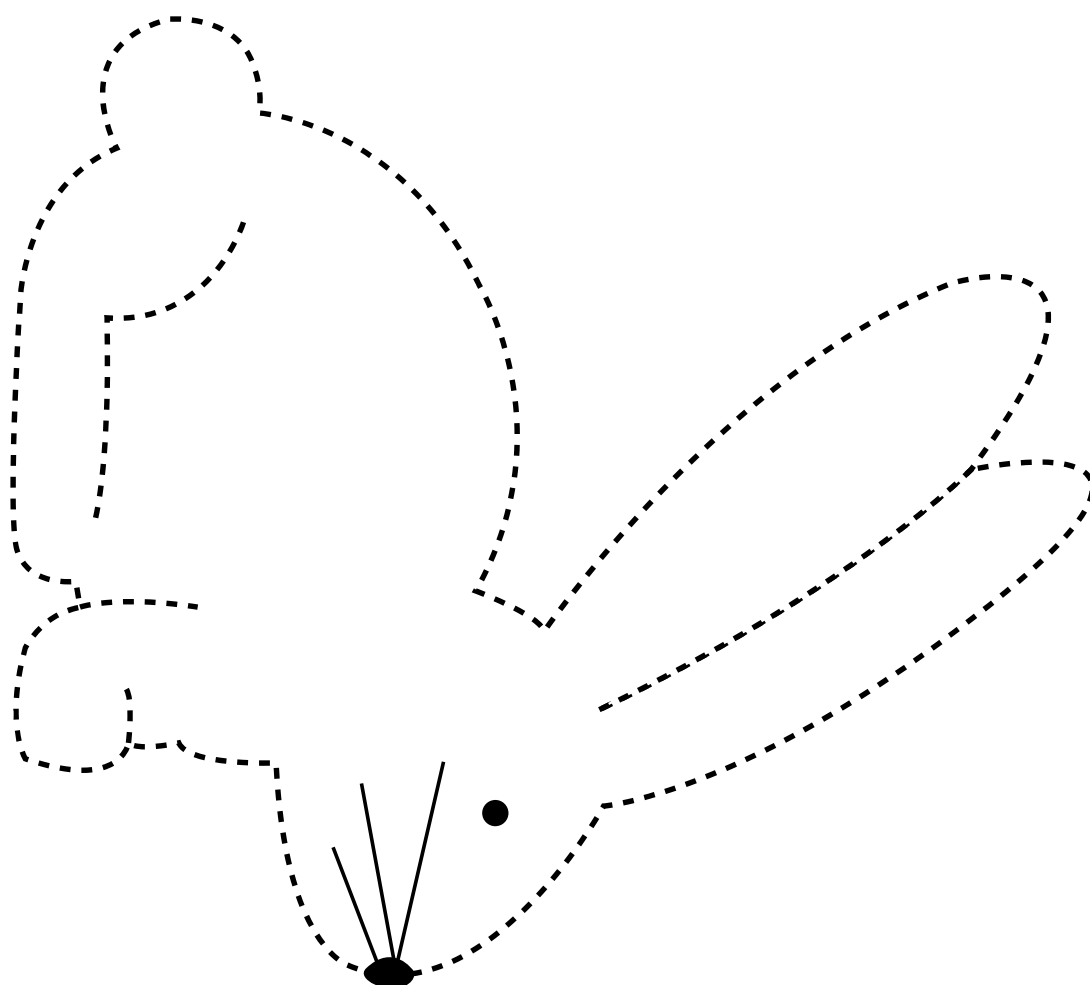

Obrysuj psa po śladzie i pokoloruj go.

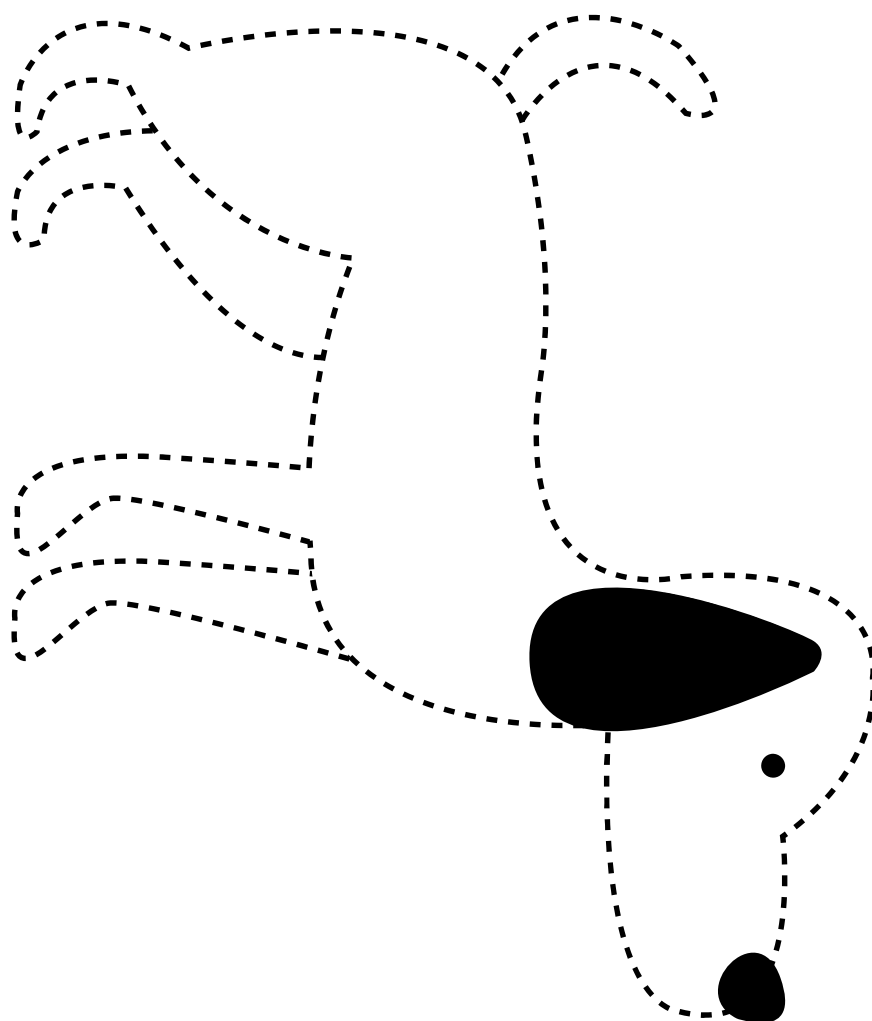

Obrysuj i pokoloruj zwierzęta.

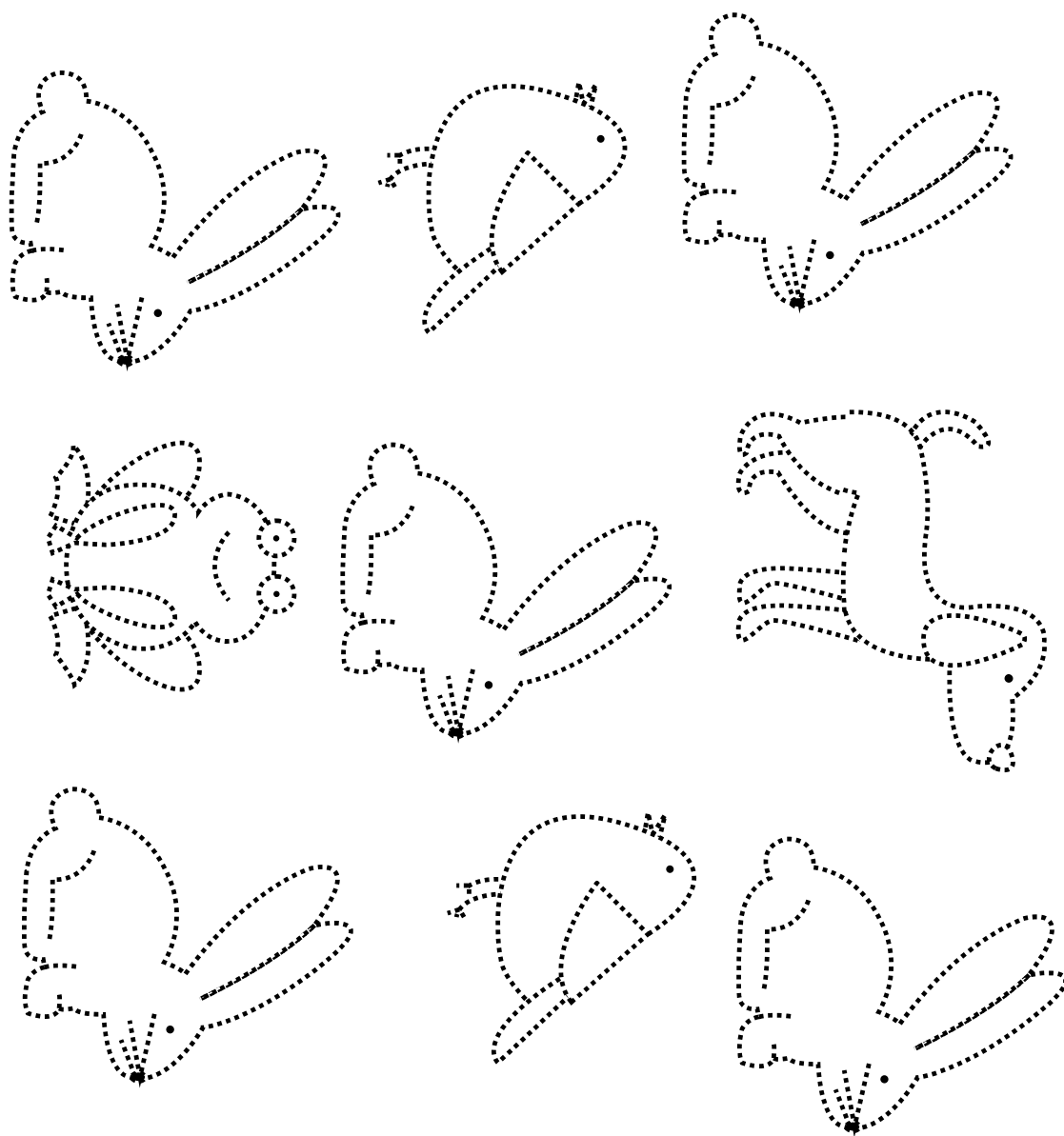

Obrysuj i pokoloruj kształty ulubionymi kolorami.

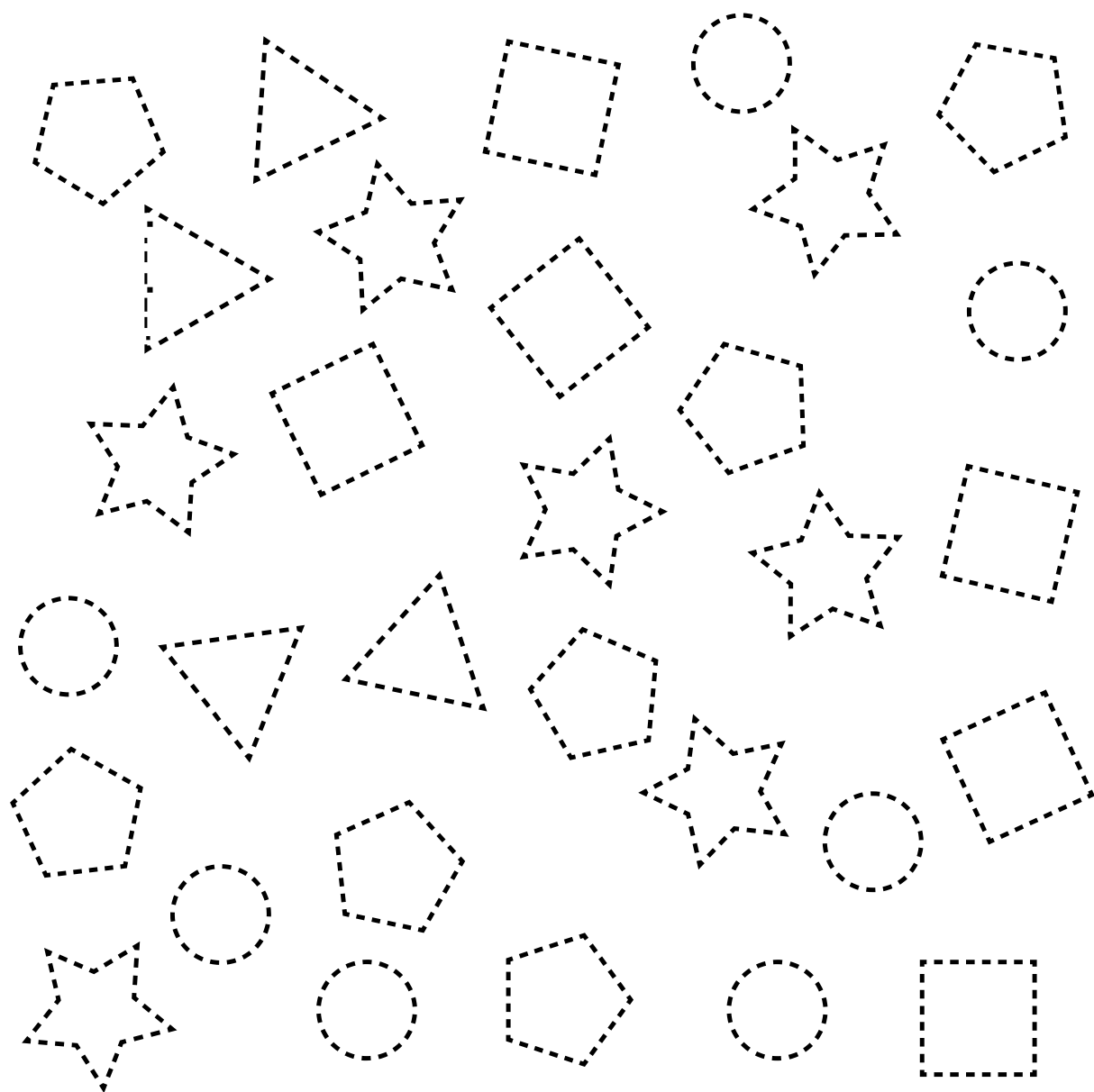

Znajdź na obrazku owoce i pokoloruj je.

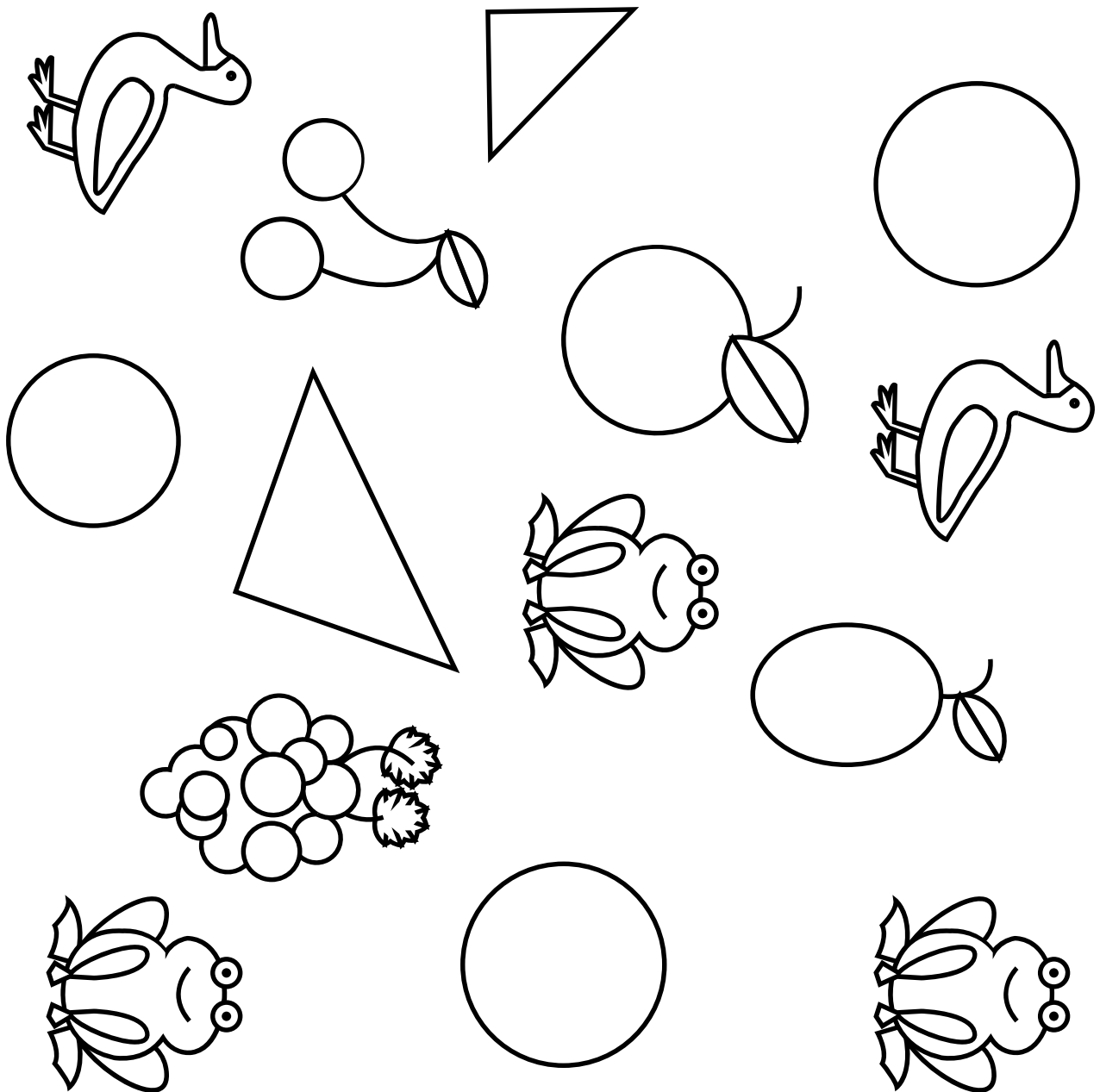

Pokoloruj kwiaty ulubionymi kolorami.

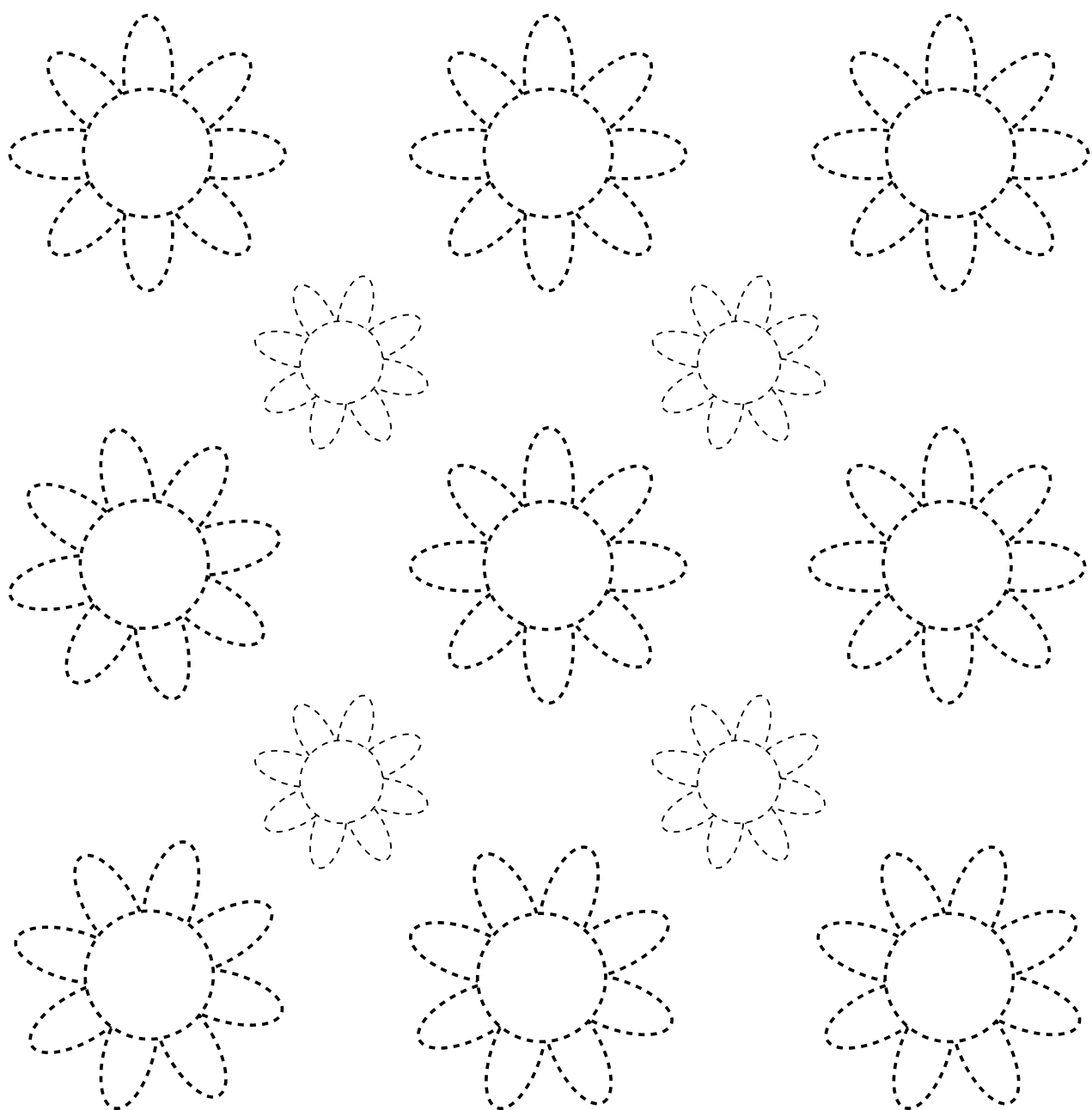

Pokoloruj trójkąty na niebiesko. Co ukryło się na obrazku?

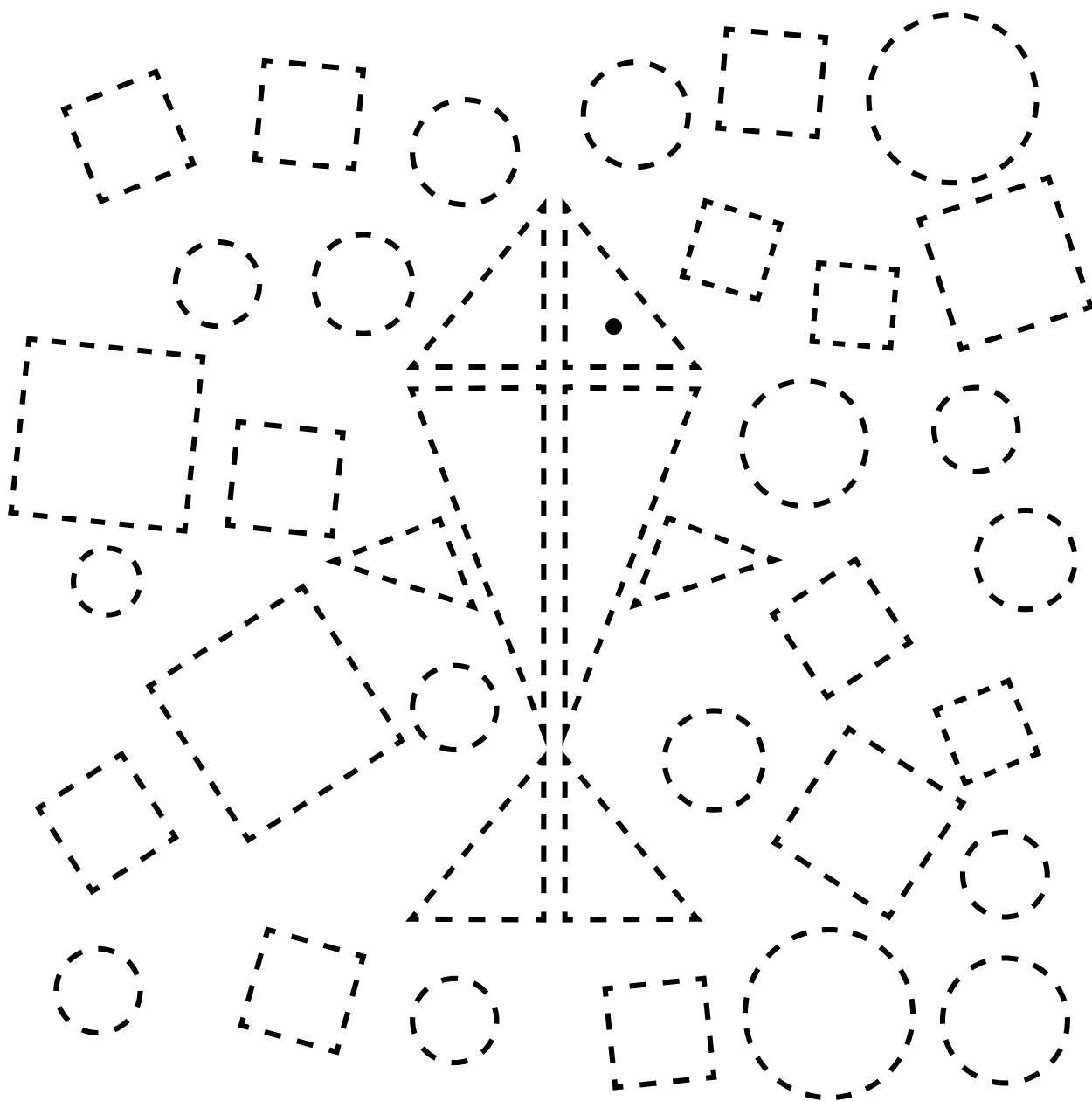

Co ukryło się na obrazku? Pokoloruj to.

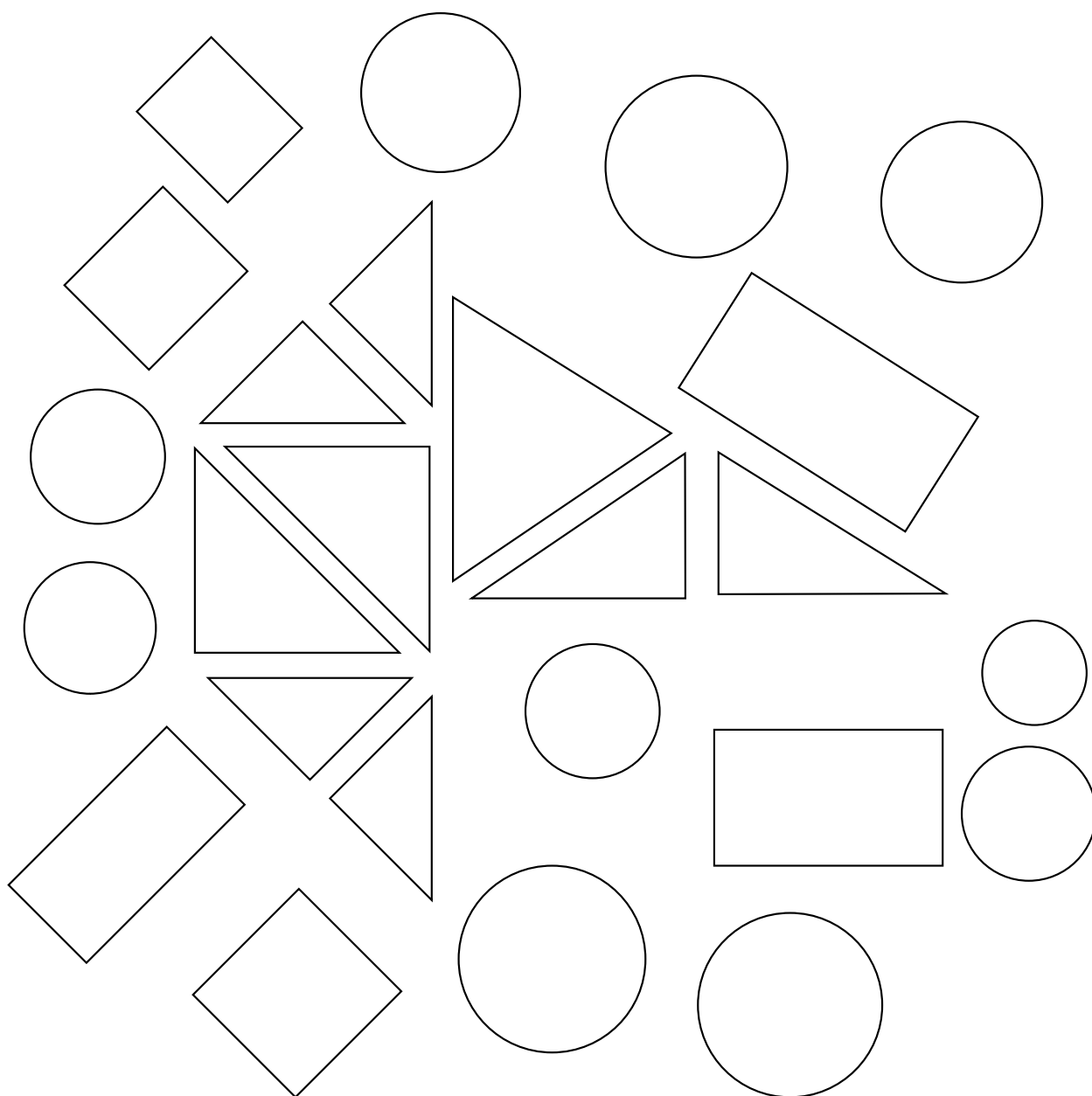

Narysuj kropki na biodronce. Pokoloruj obrazek.

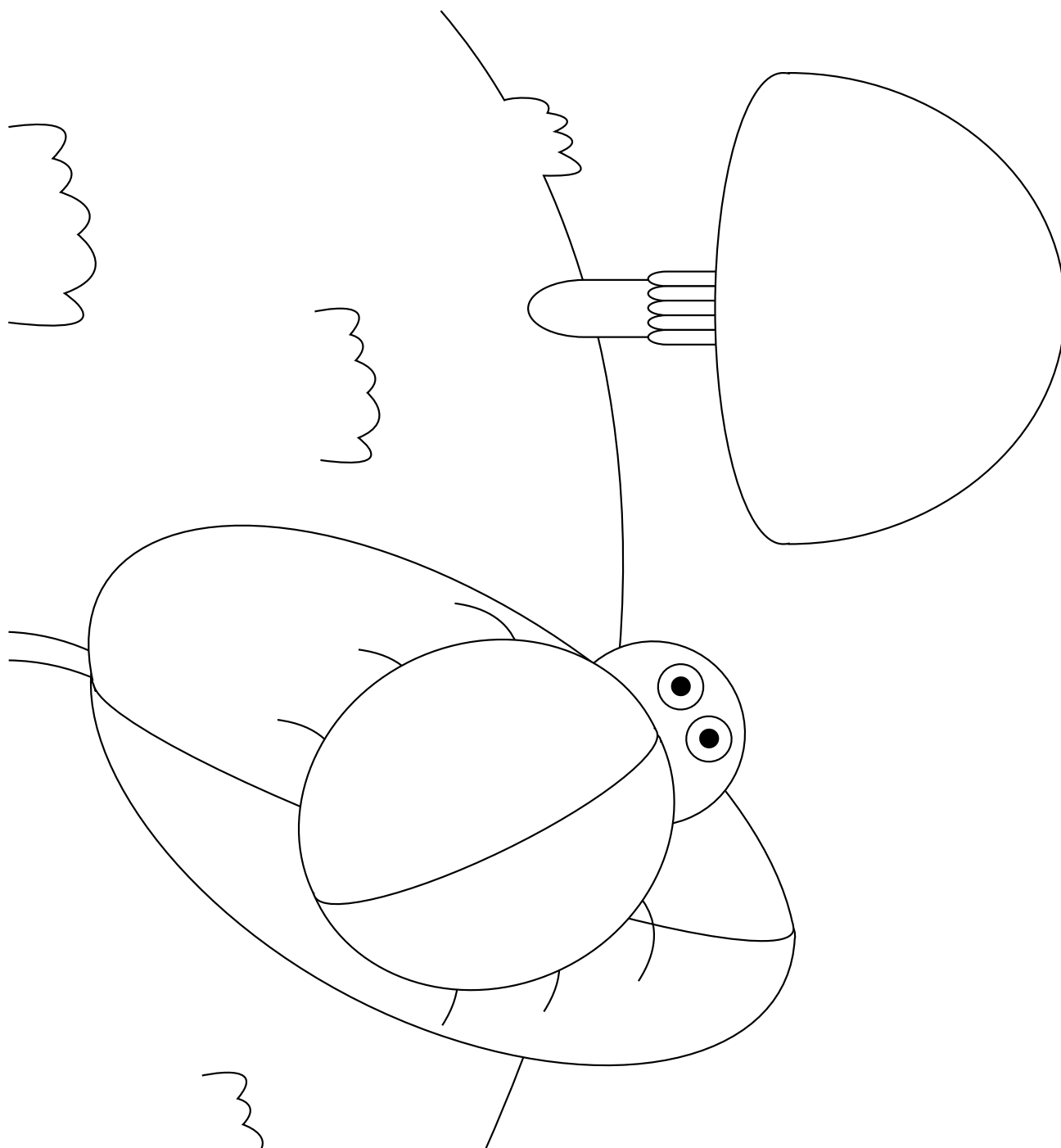

Narysuj rybkę według wzoru. Pokoloruj pozostałe rybki.

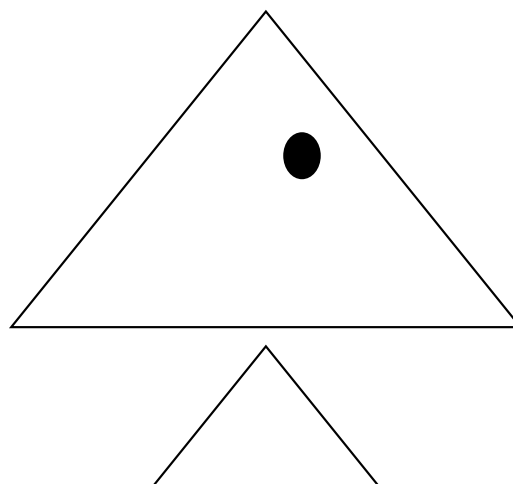
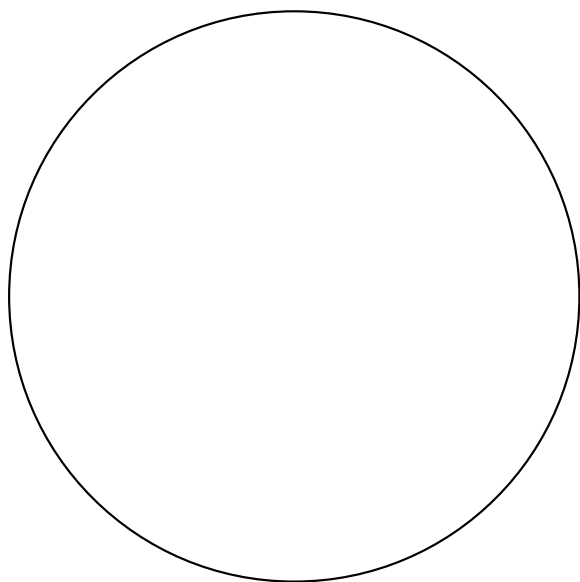
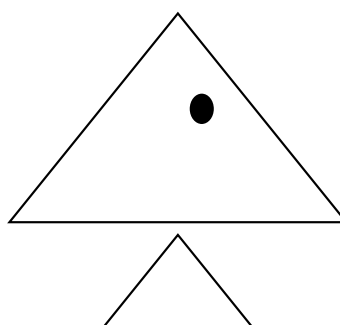
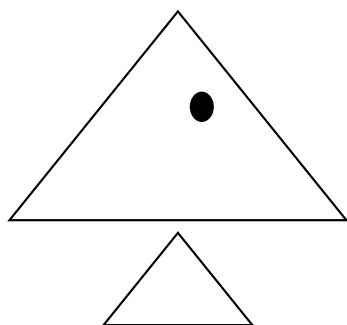
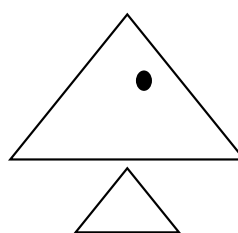
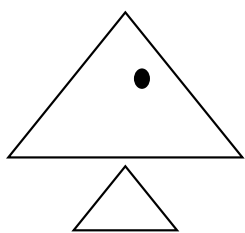

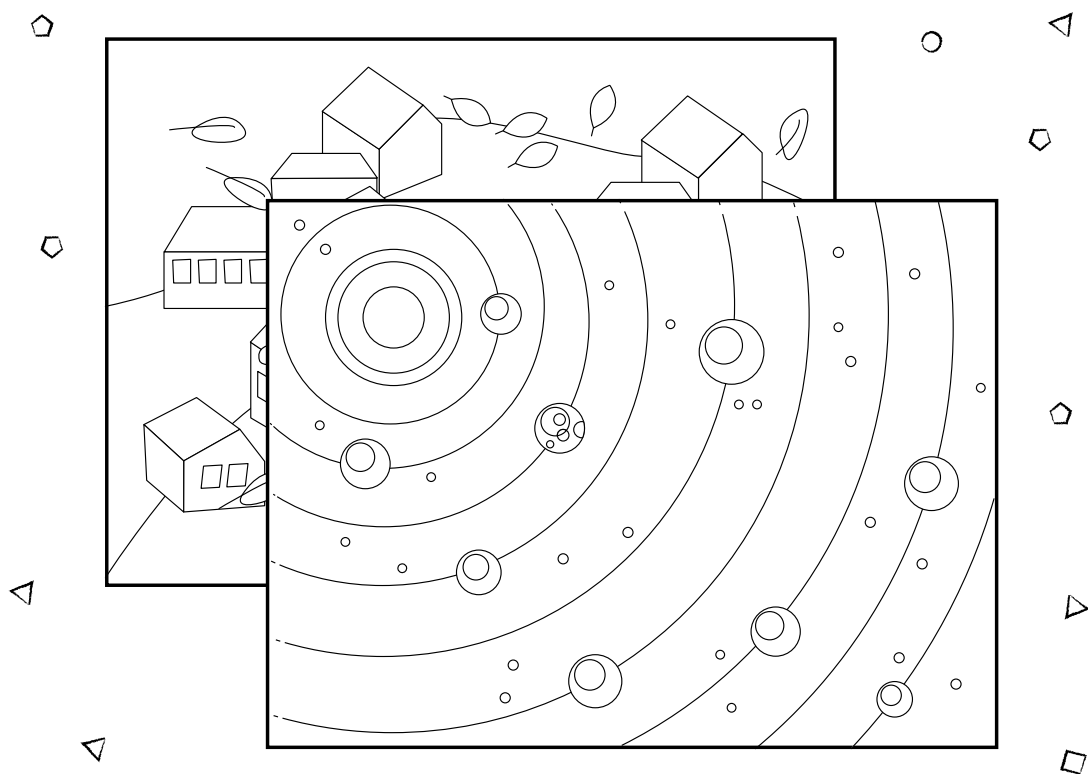

W KRAINIE KOLORÓW

6 latek rysuje

Pokoloruj obrazek. Dorysuj jeszcze jednego królika, kreta i ptaszka.

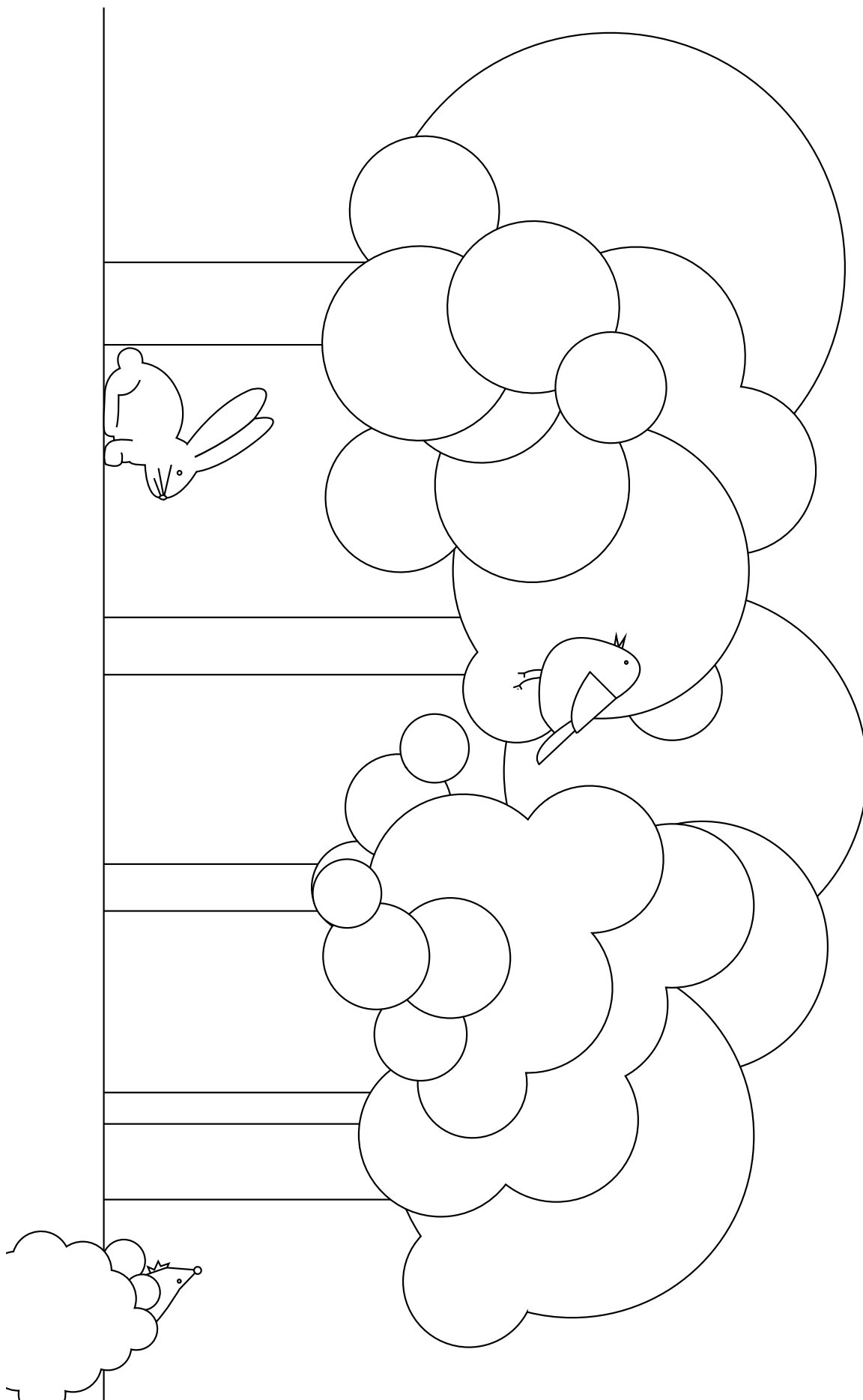

Pokoloruj obrazek. Wymyśl własne nazwy dla planet.

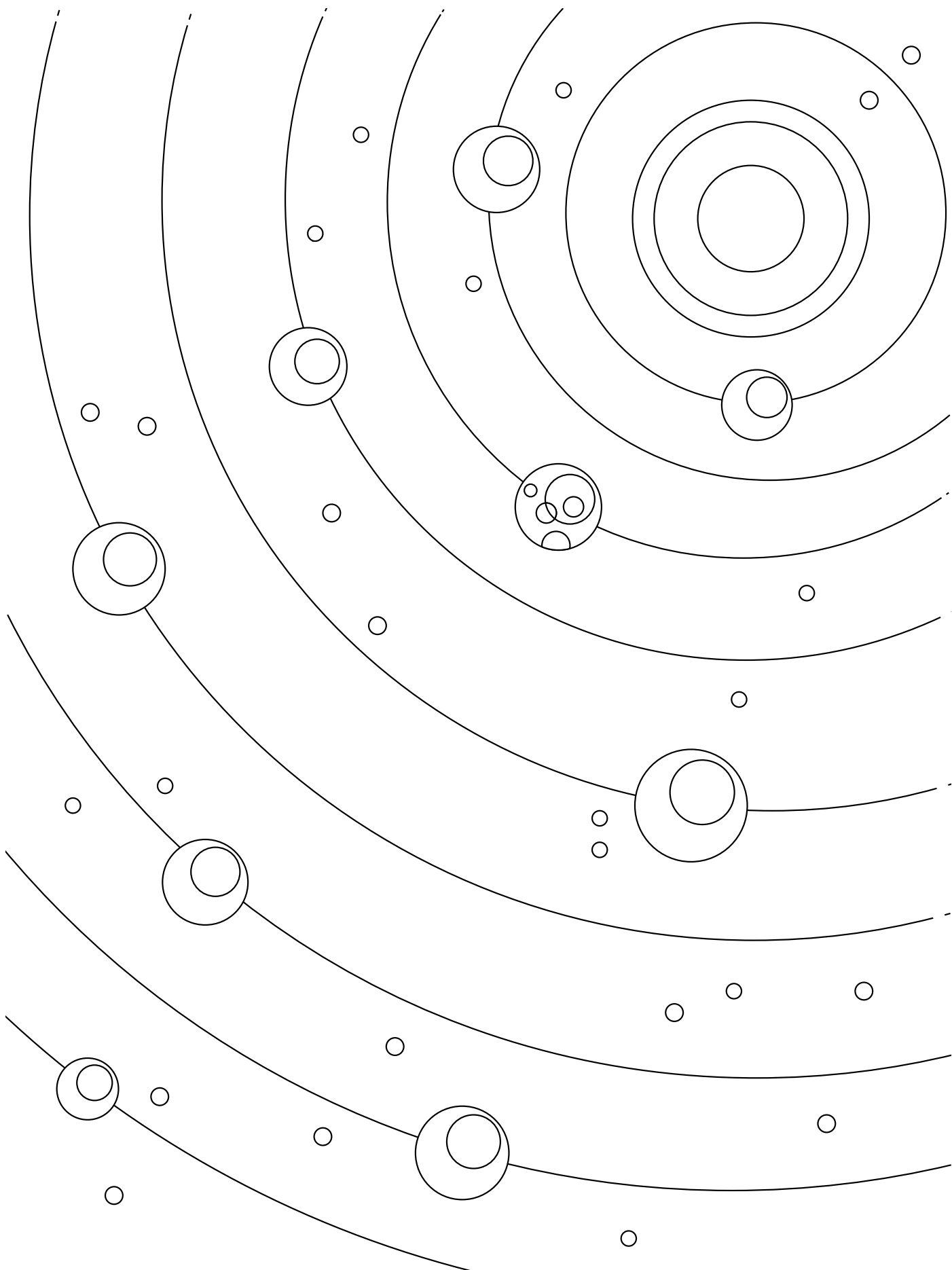

Pokoloruj rysunek. Dorysuj jeszcze jedną ważkę.

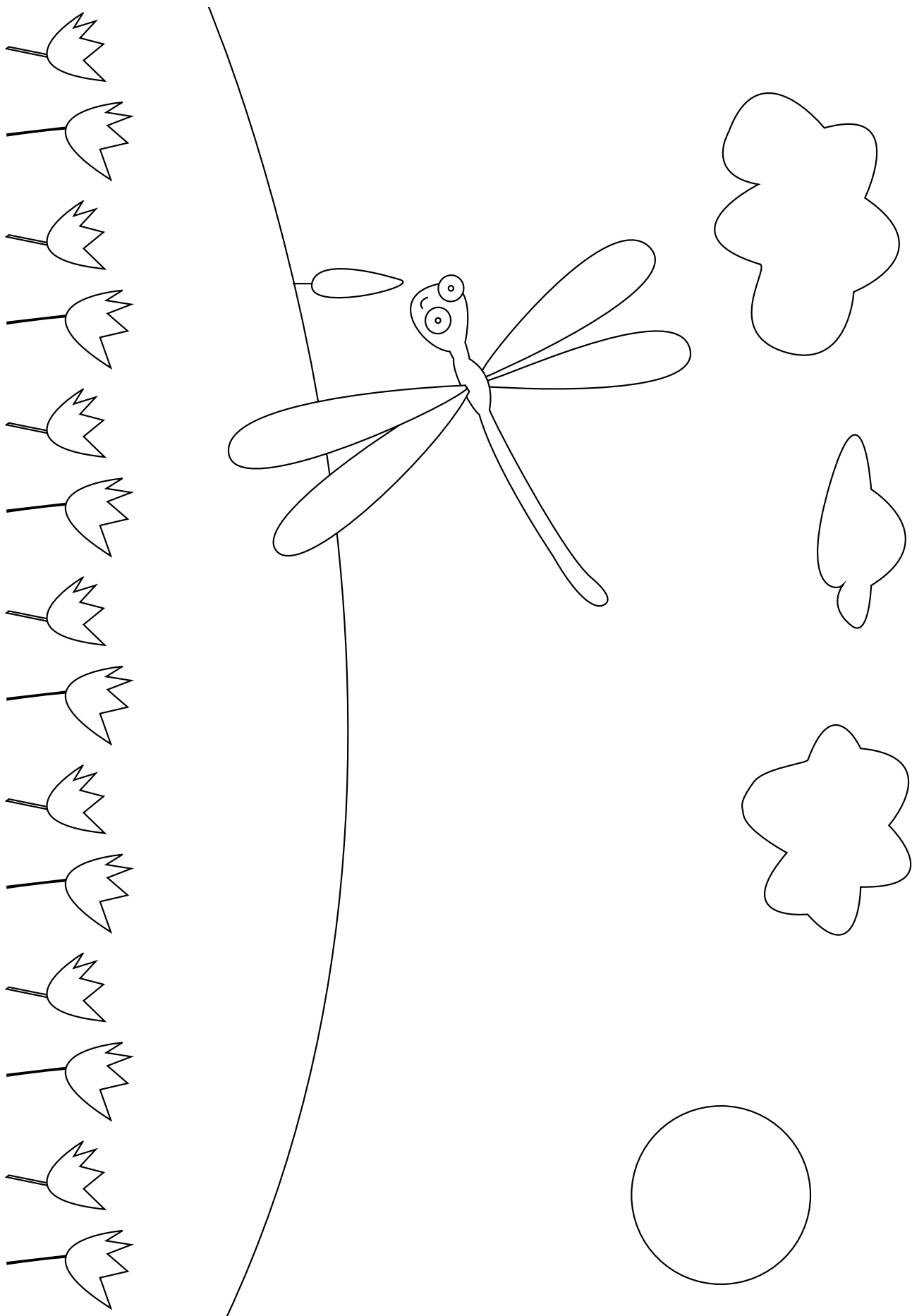

Narysuj portrety Mamy i Taty. Udekoruj ramki.

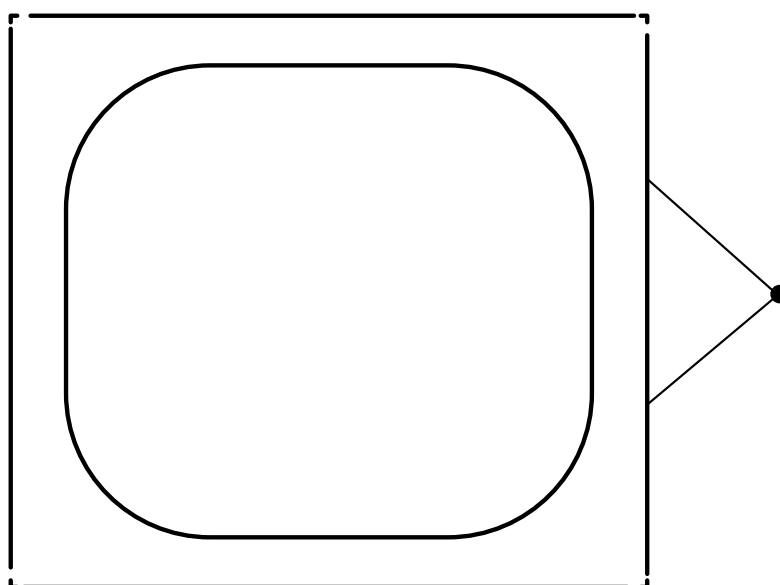
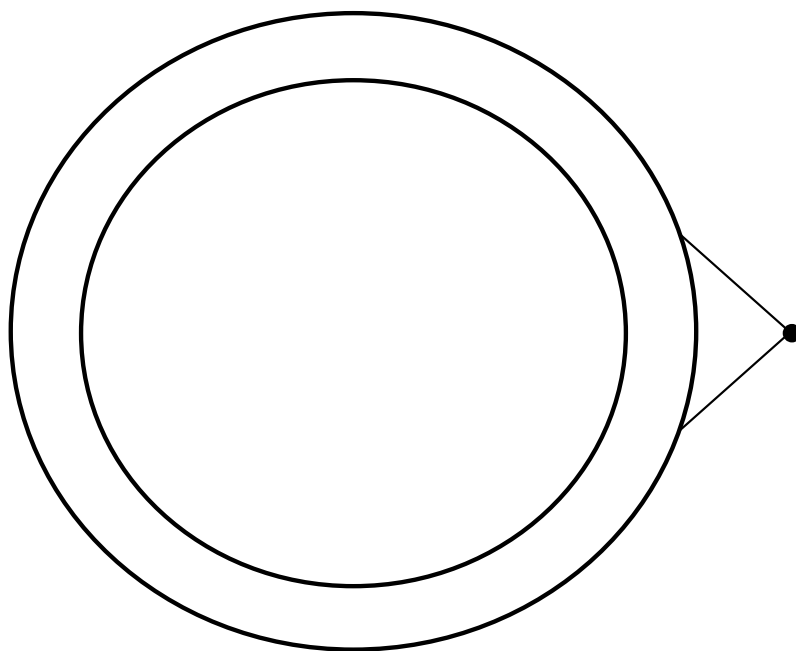

Pokoloruj liście wiosennymi kolorami.

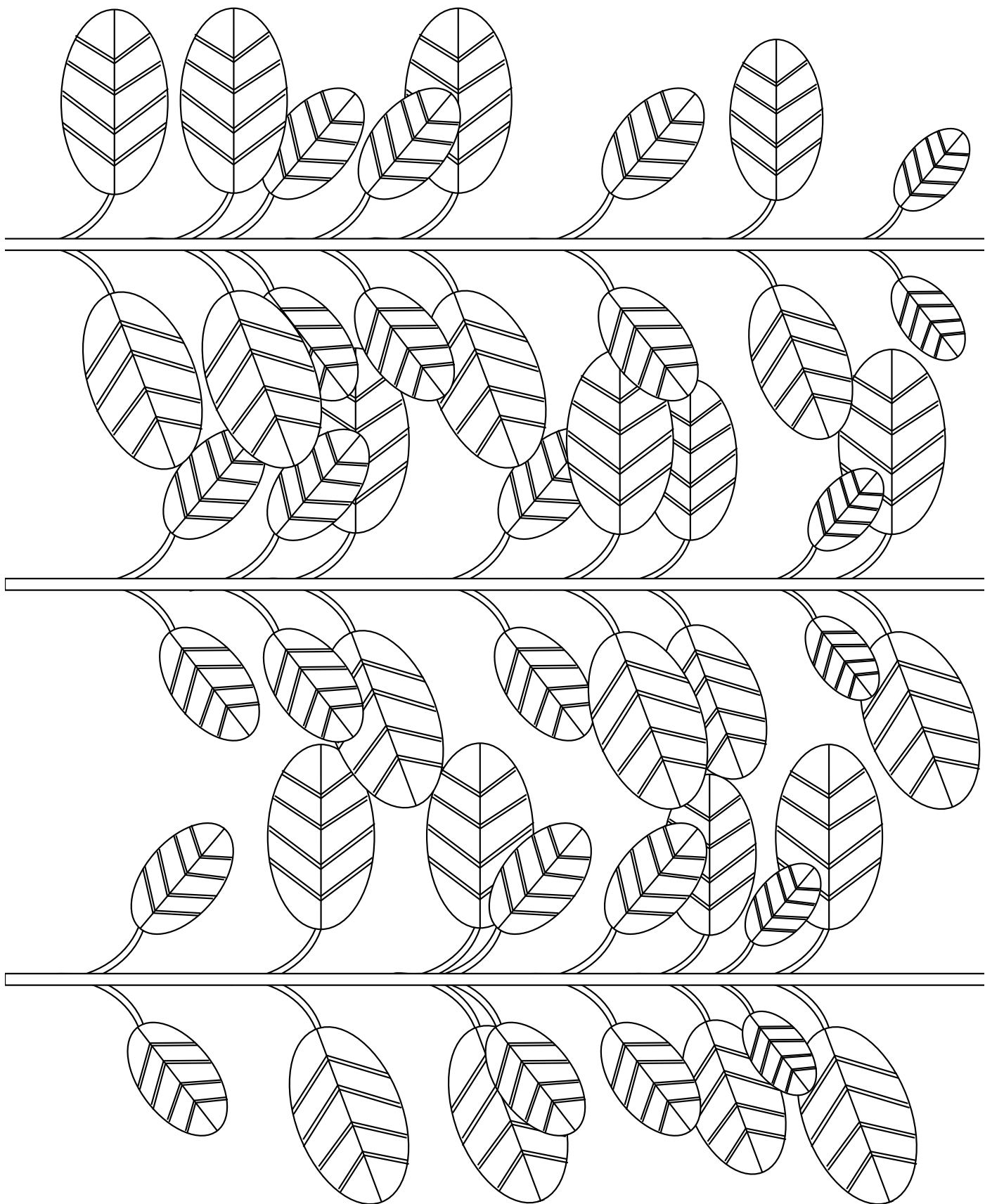

Pokoloruj obrazek. Z jaką porą roku kojarzy Ci się?

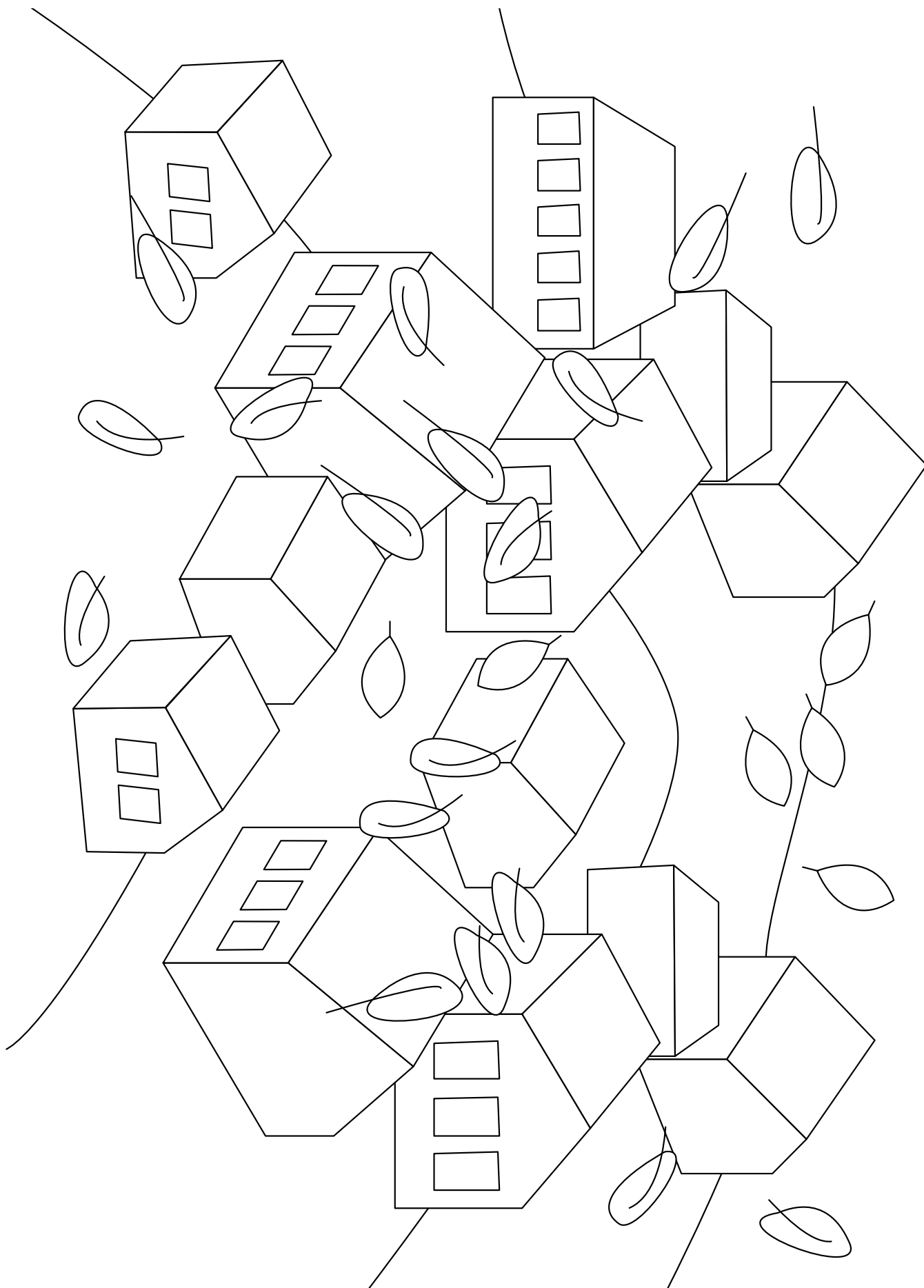

O jakich prezentach marzysz? Narysuj je w dymkach.

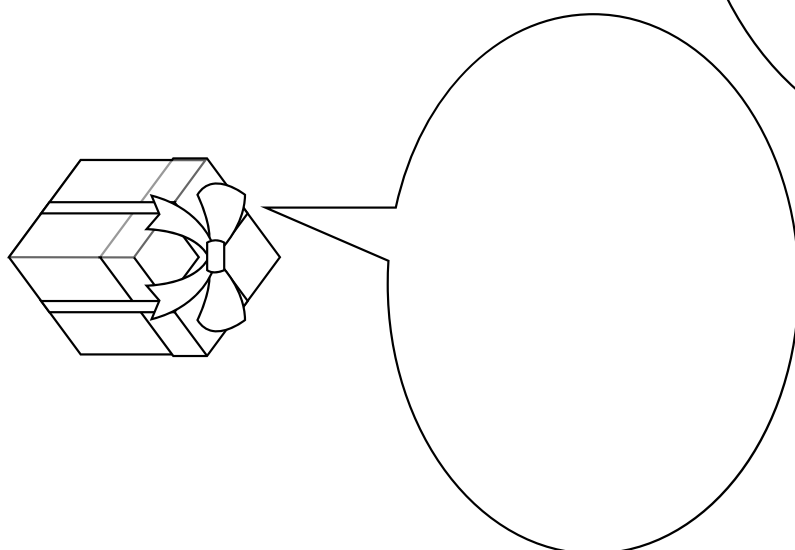
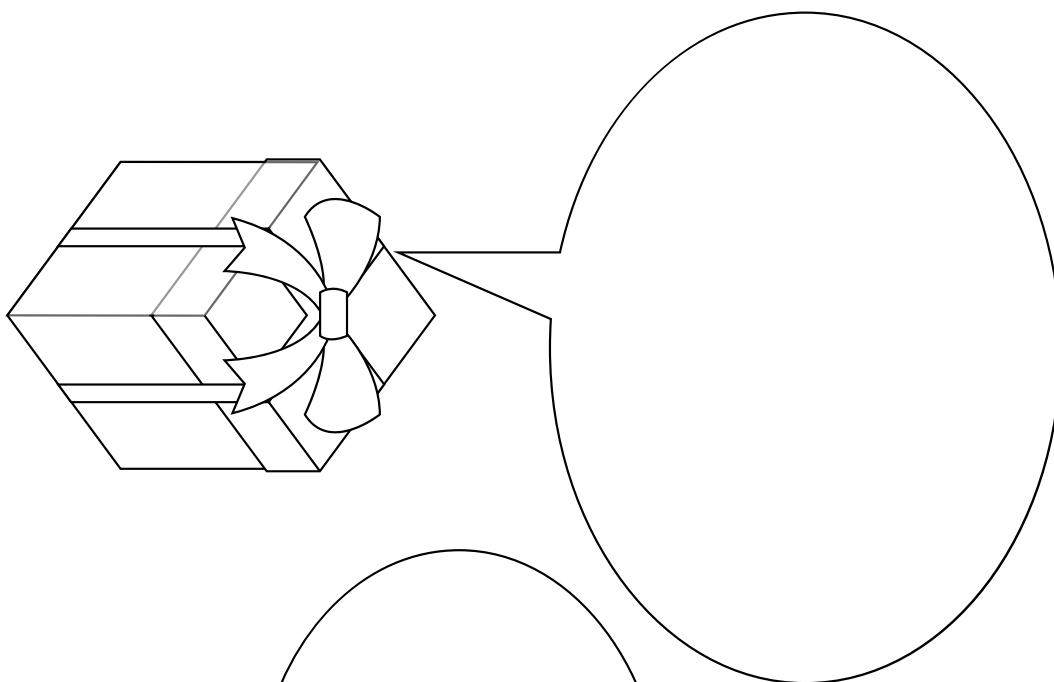
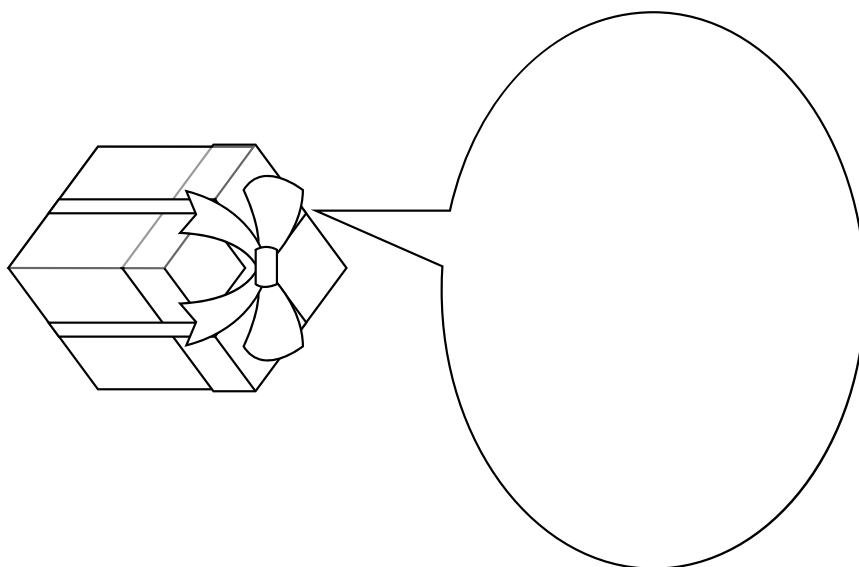

Dorysuj na boisku bramkarza, graczy oraz piłkę.

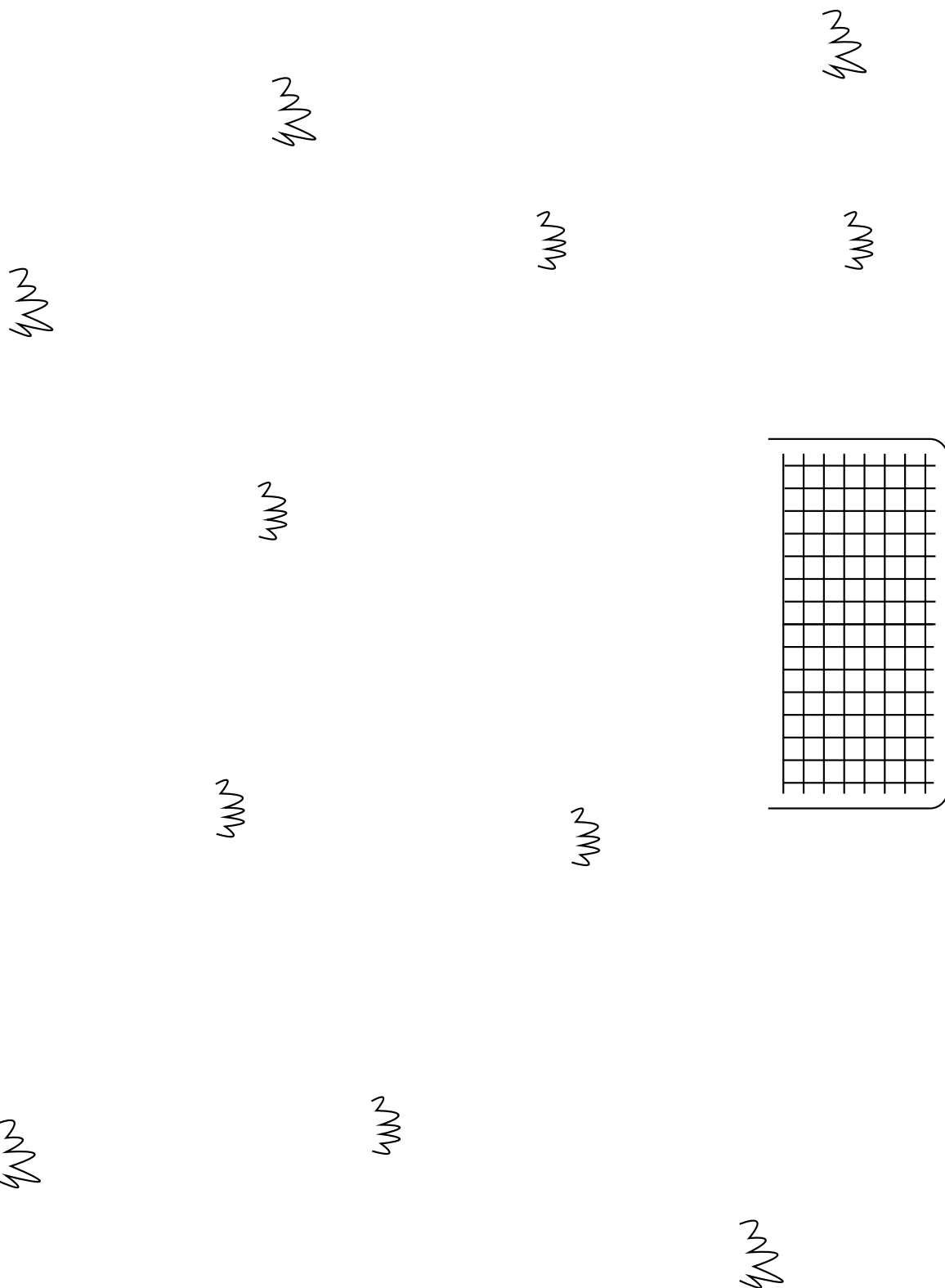

Narysuj na talerzach cztery różne posiłki, które podano na obiad.

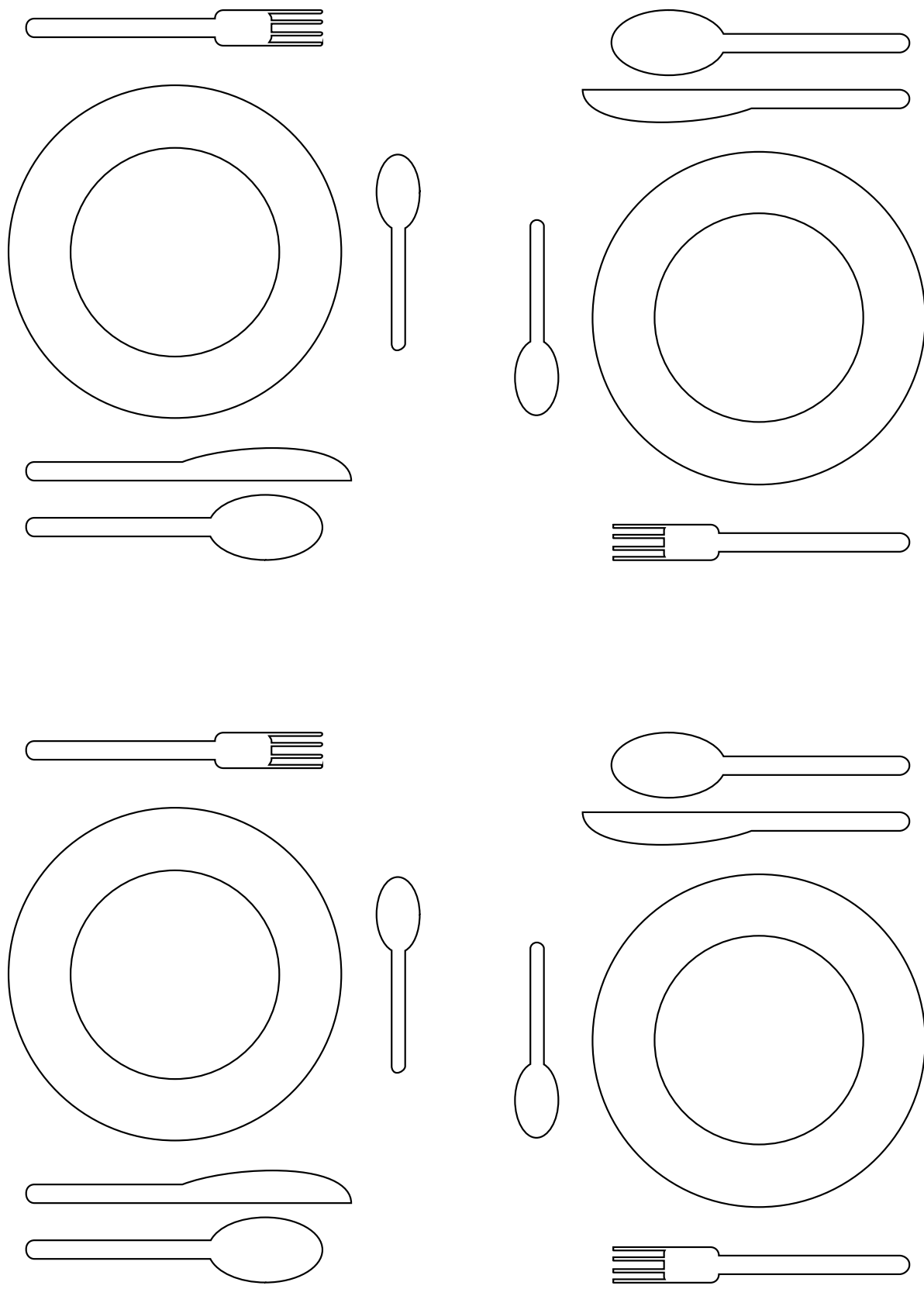

Obrysuj wieżę i dokończ rysunek.

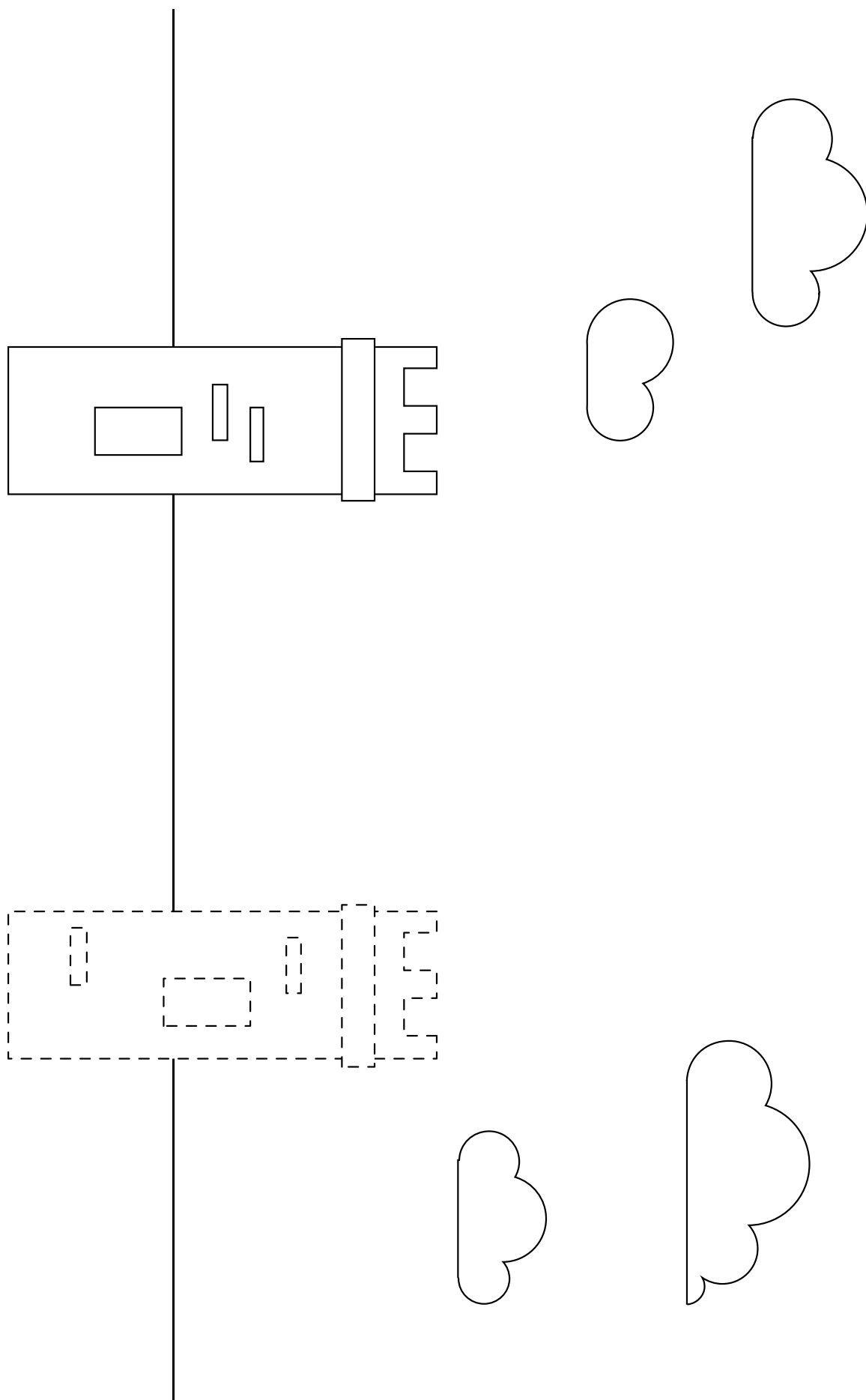

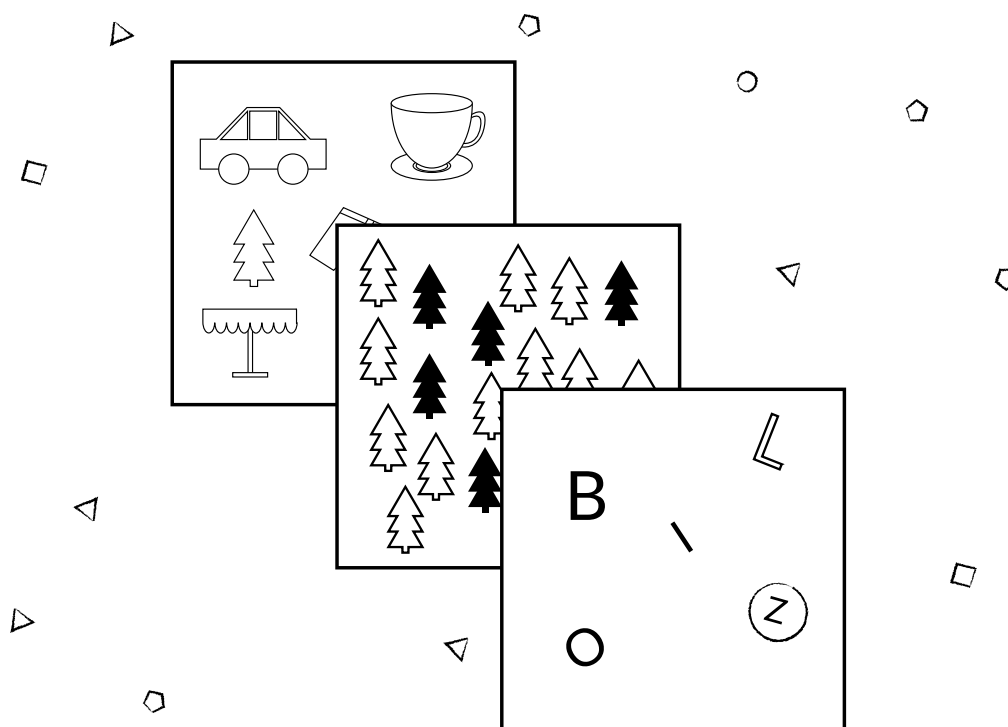

W KRAINIE KOLORÓW

6 latki rysują razem

Narysuj odbicie lustrzane kurki.

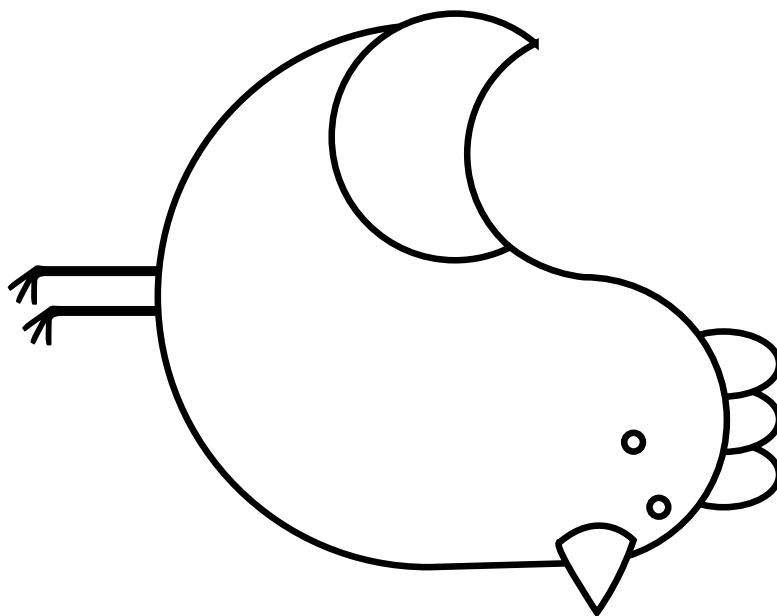

Pokoloruj gwiazdki i policz je.

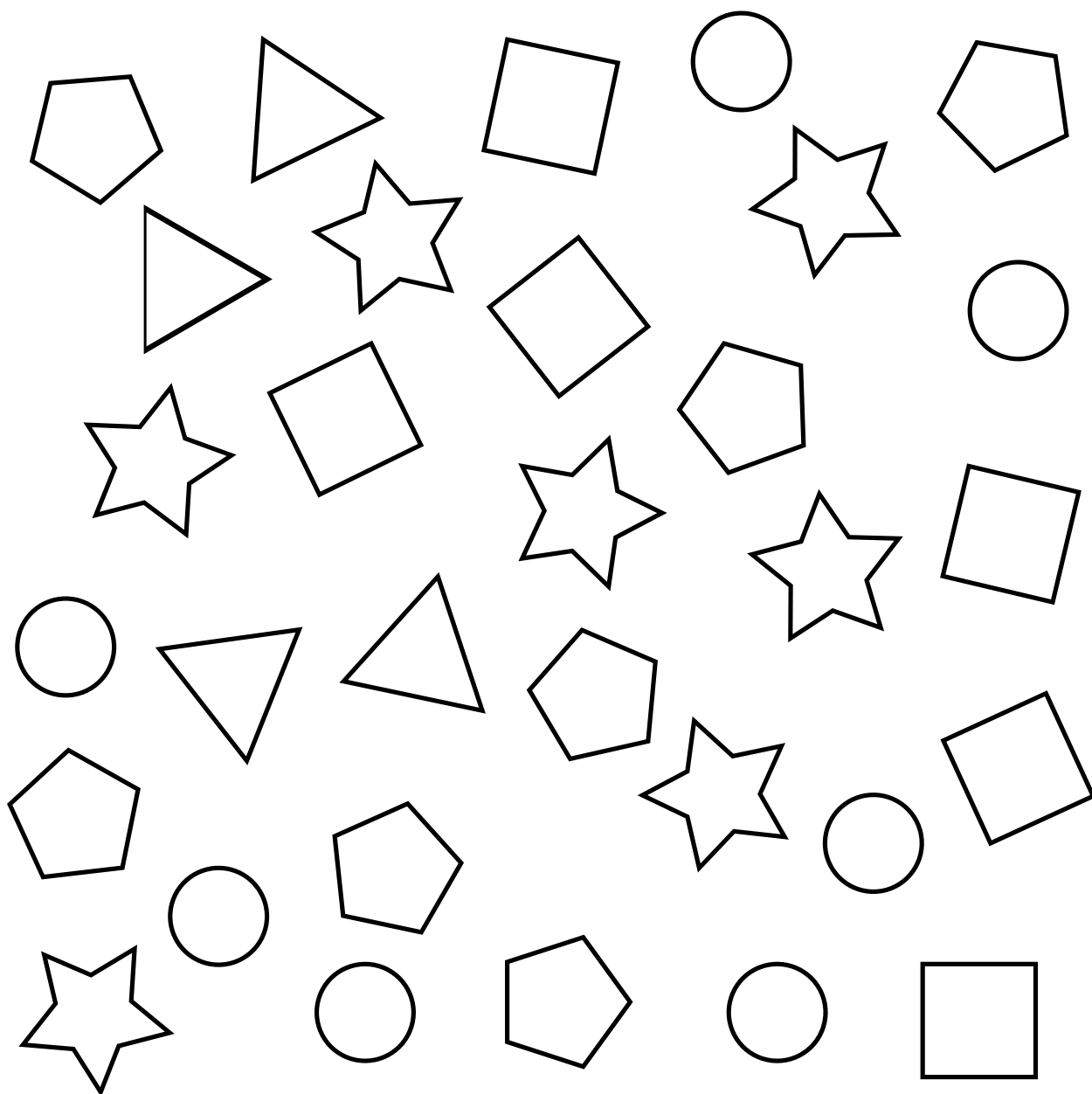

Udekoruj filiżankę.

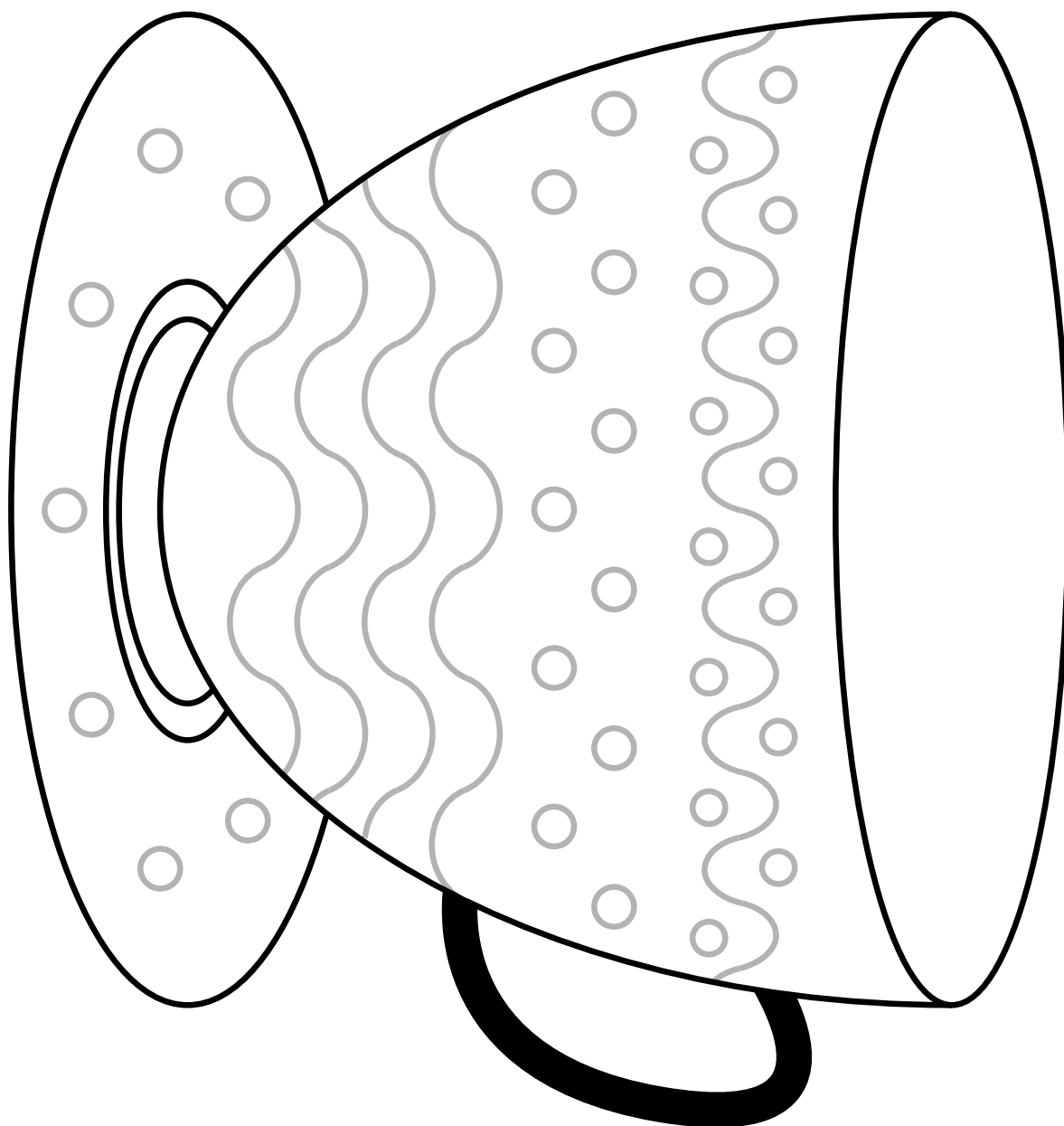

Udekoruj balon. Dorysuj i udekoruj jeszcze dwa balony.

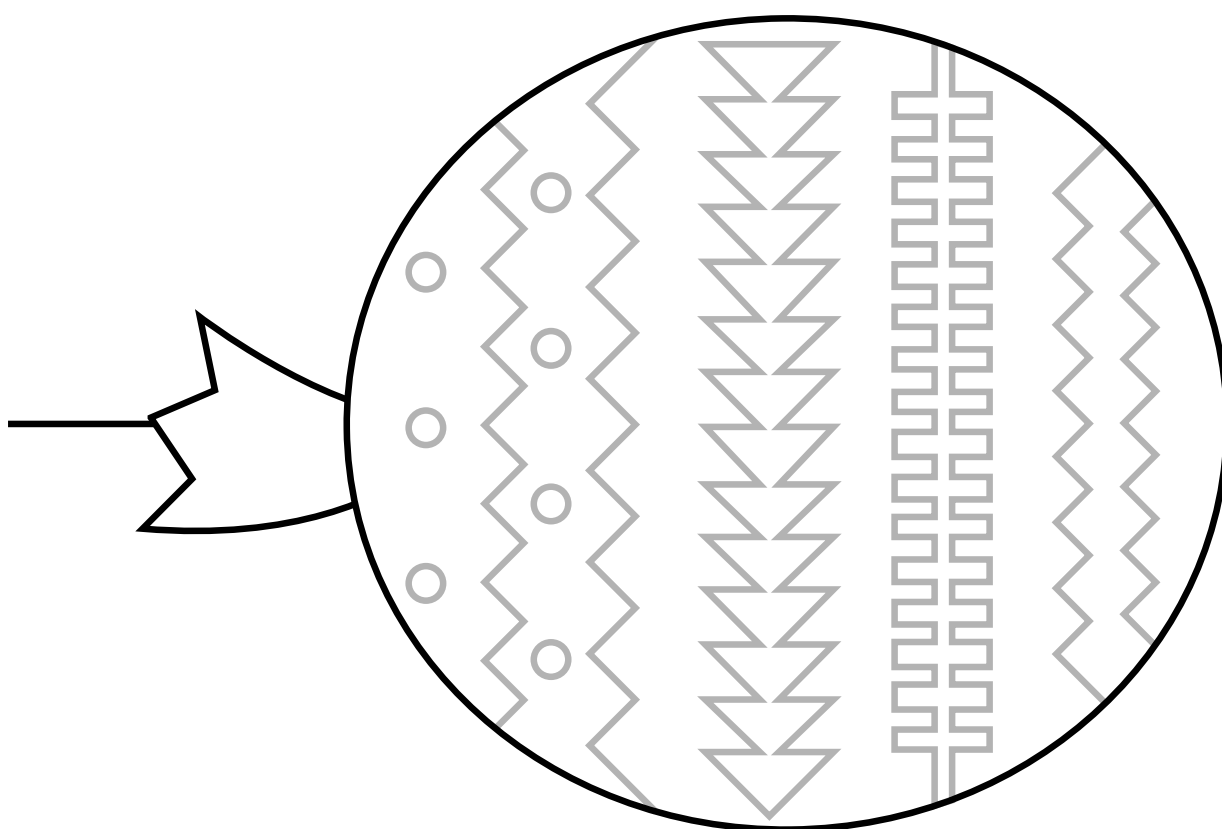

Pokoloruj wzór tak, aby był symetryczny

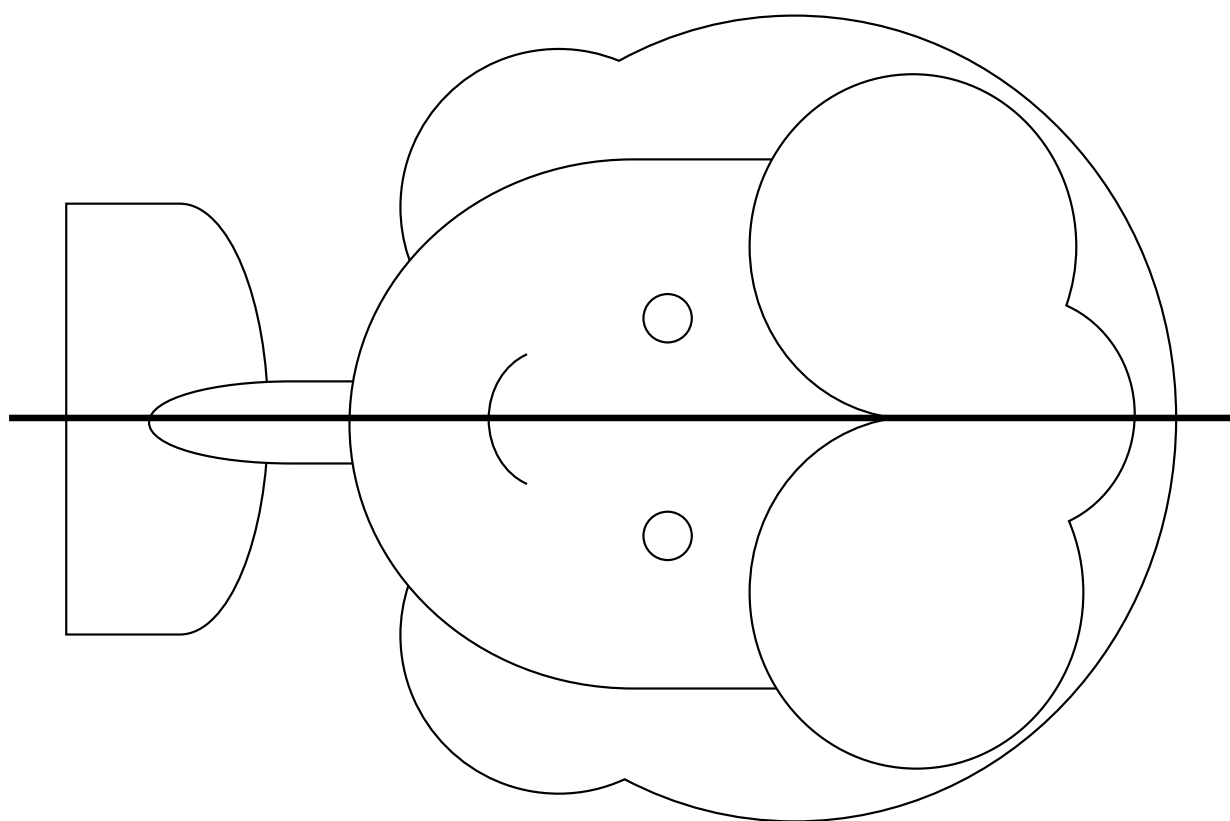

Narysuj wskazówki na zegarze.

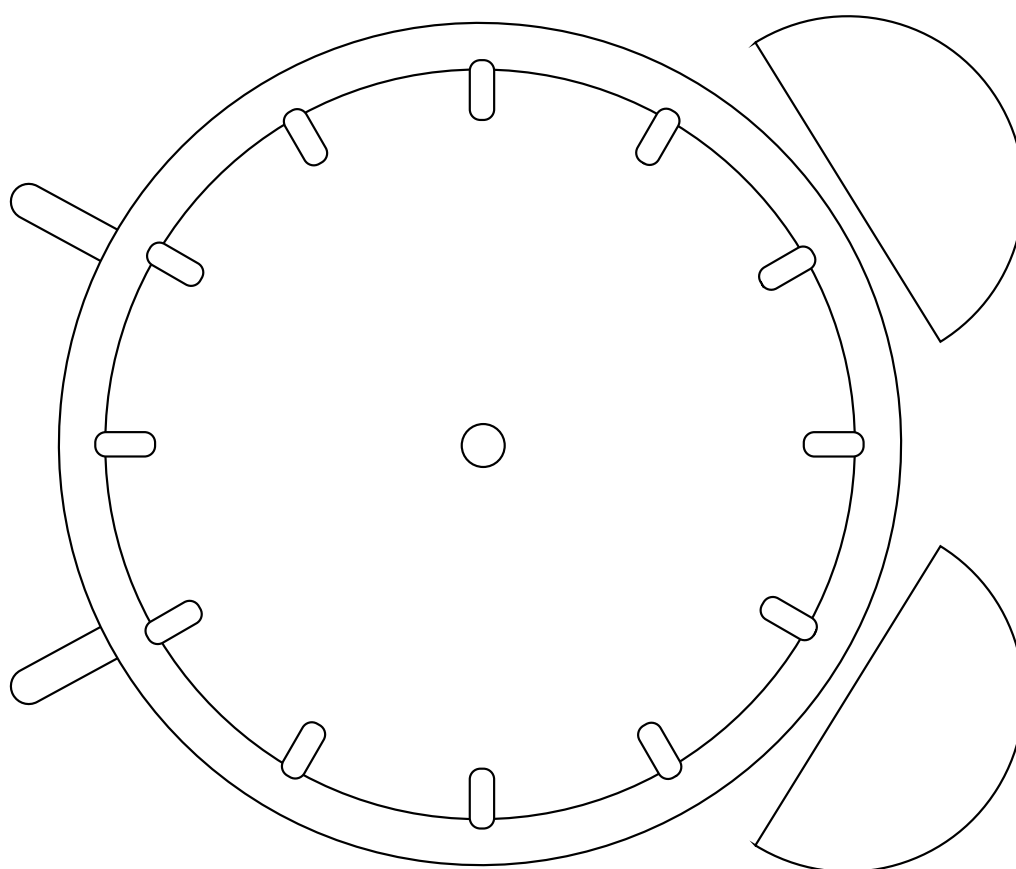

Pokoloruj akwarium.

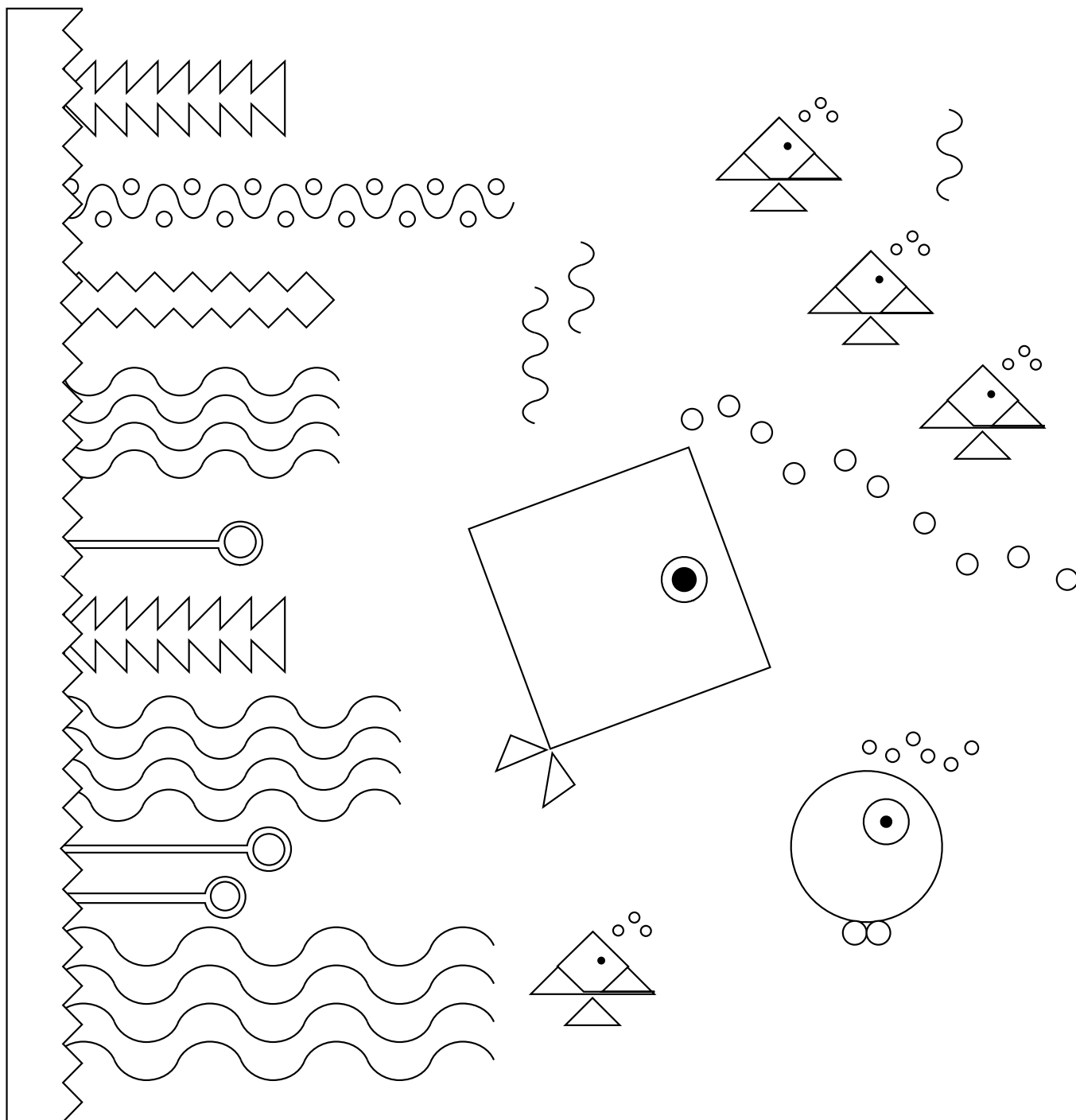

Pokoloruj uśmiechnięte buźki.

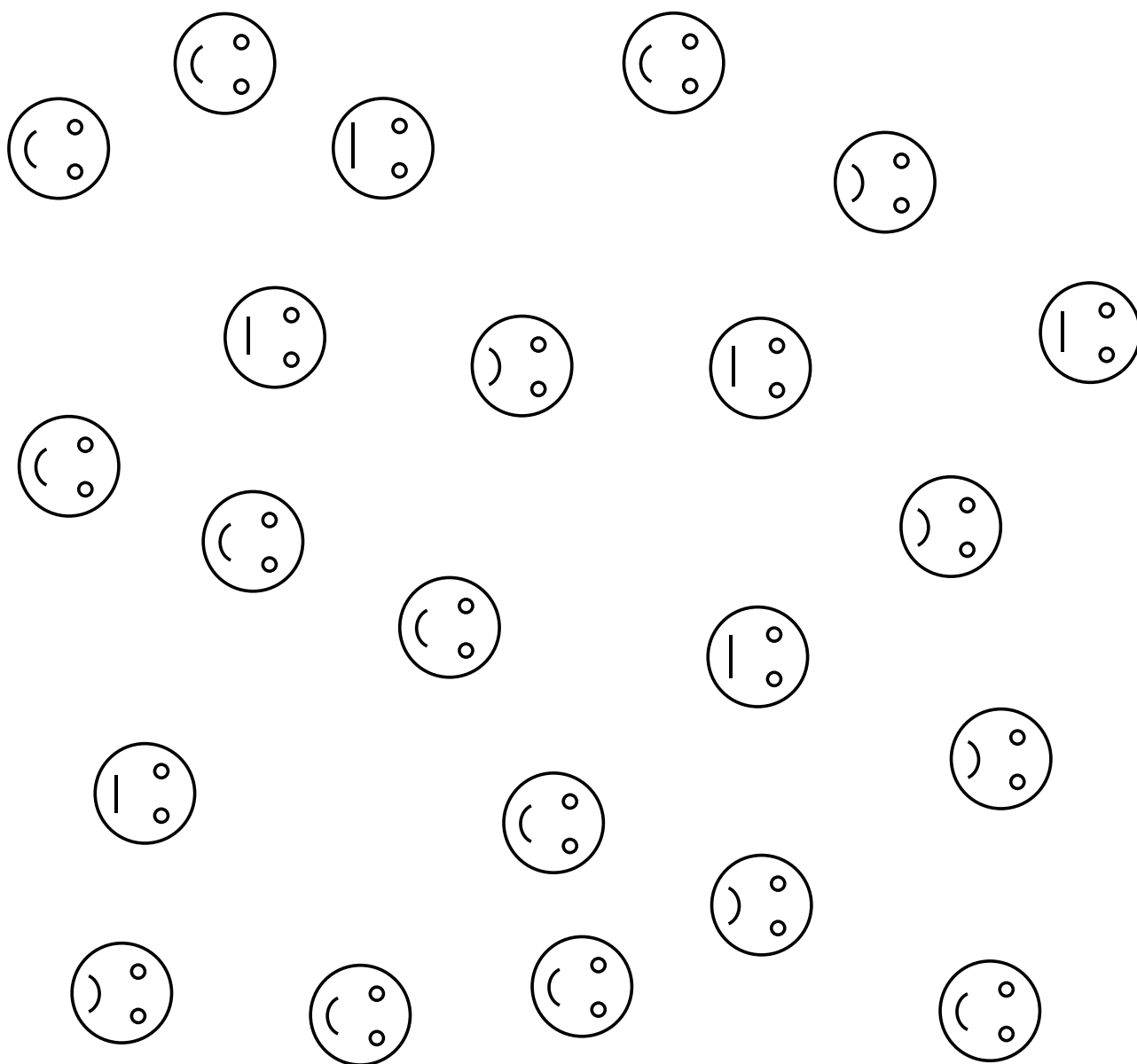

Pokoloruj rzeczy, których nazwy zaczynają się na literę S.

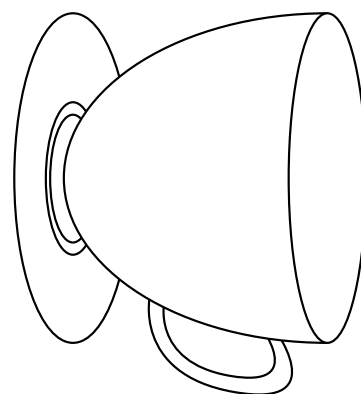
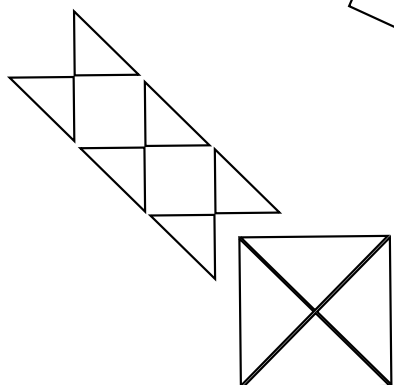
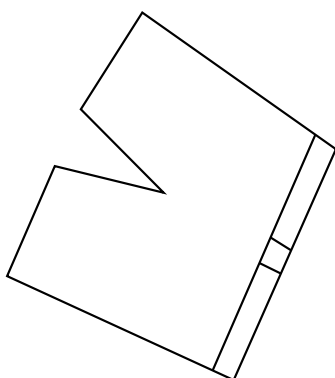
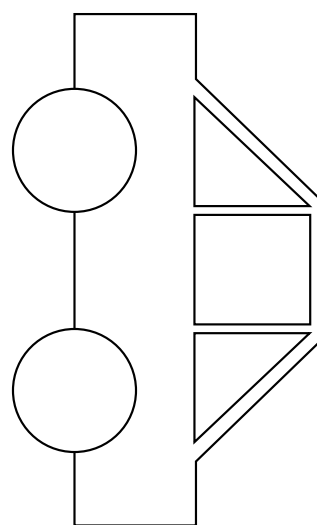
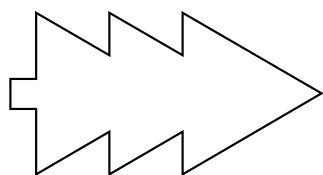
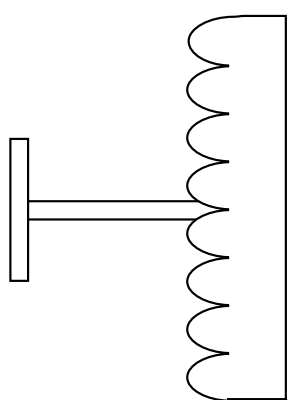

Dokończ rysunki, zmieniając kształty w coś innego.

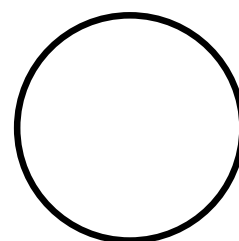
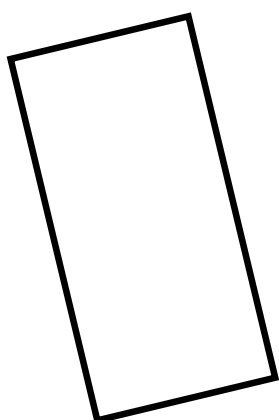
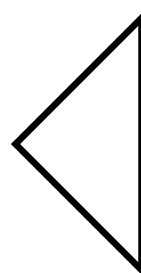
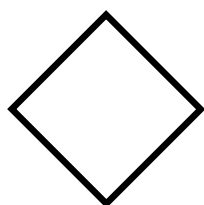

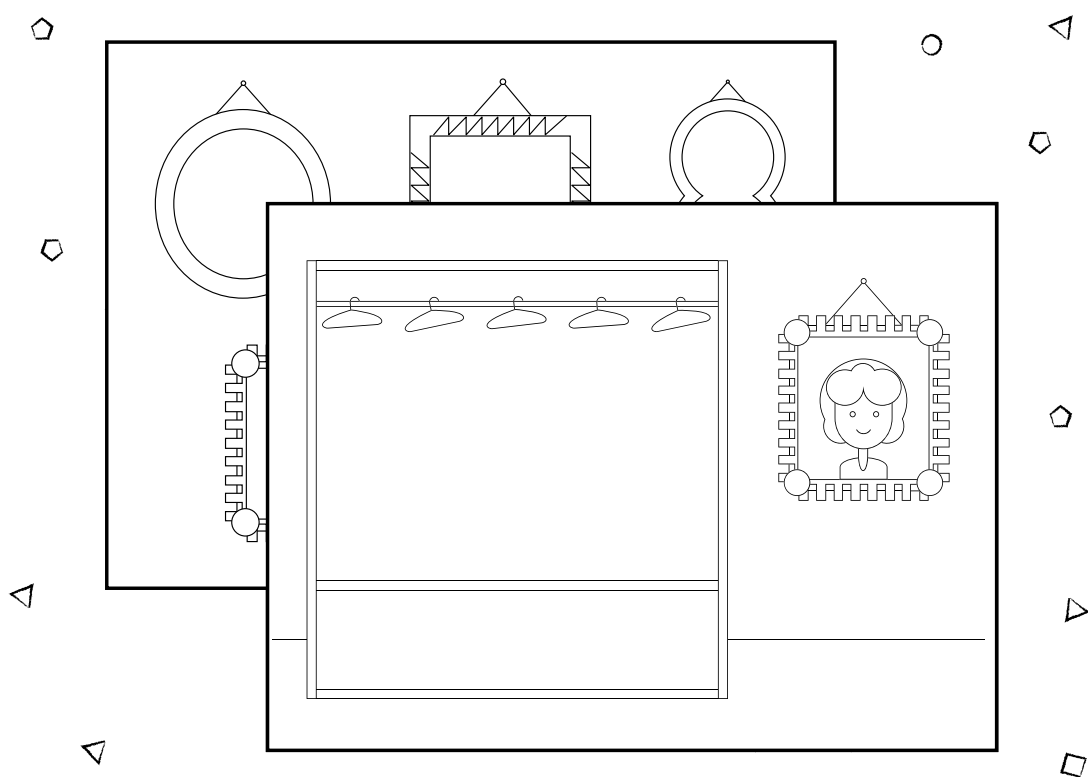

W KRAINIE KOLORÓW

Wyobraź sobie

Jakie ubrania wiszą w szafie? Narysuj je.

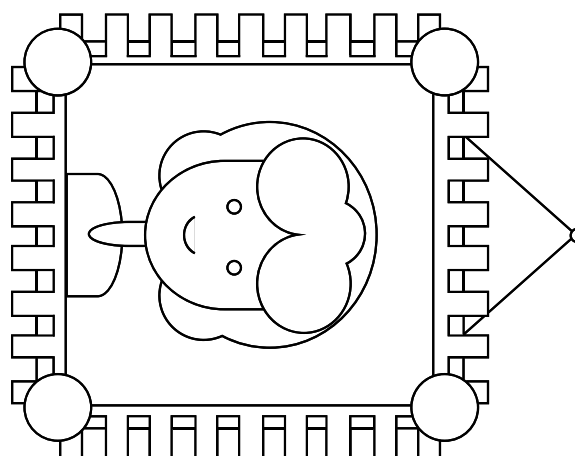
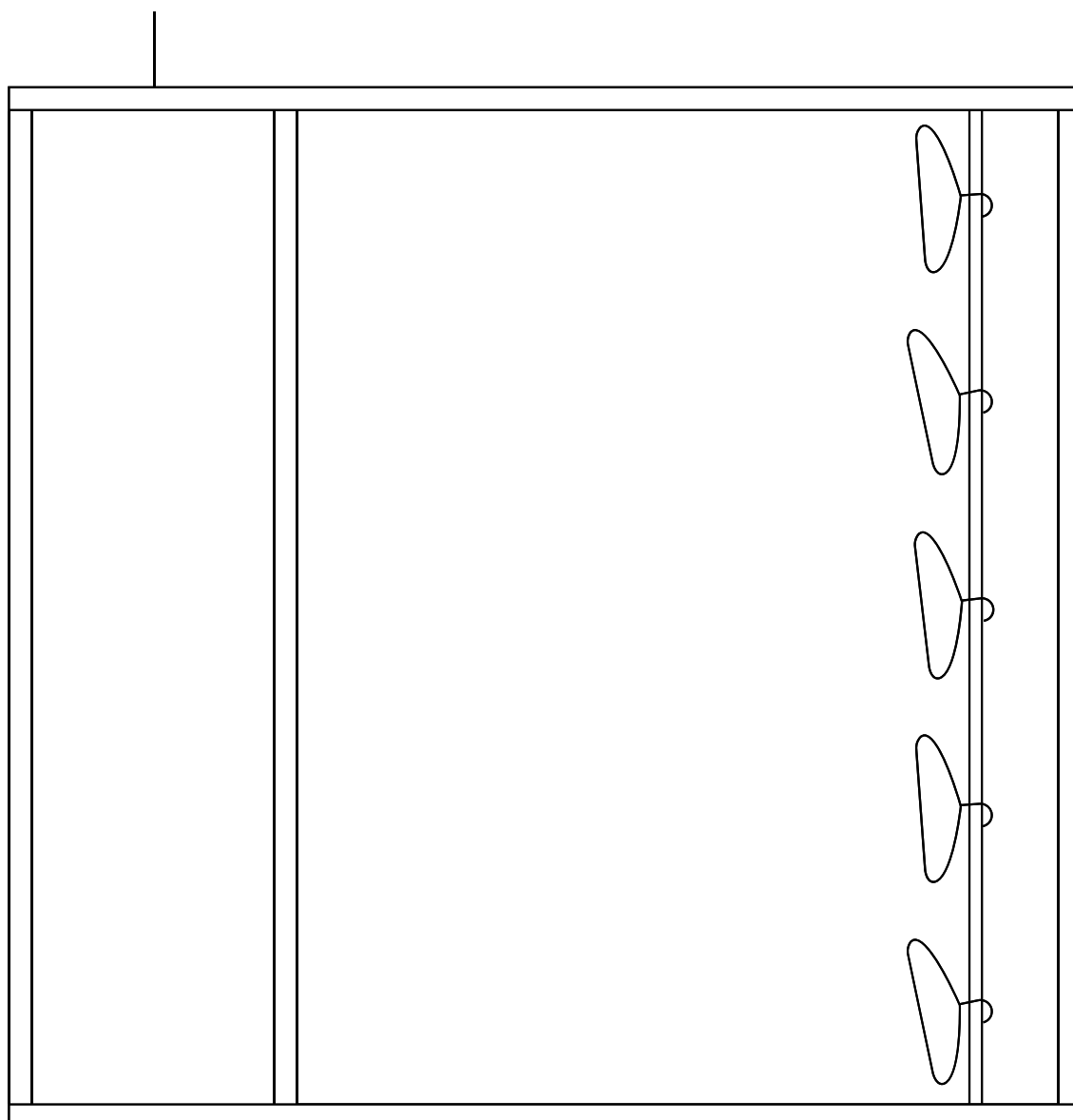

Co można ulepić z piasku? Narysuj to.

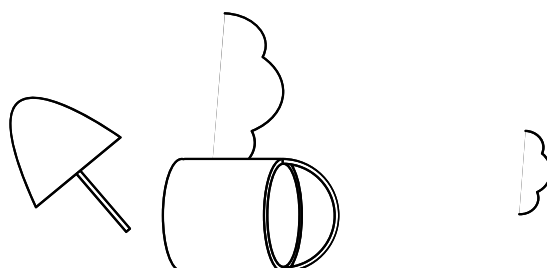

Co przedstawiają obrazy w muzeum? Narysuj te obrazy.

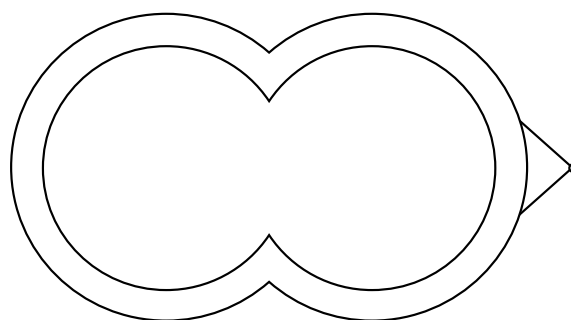
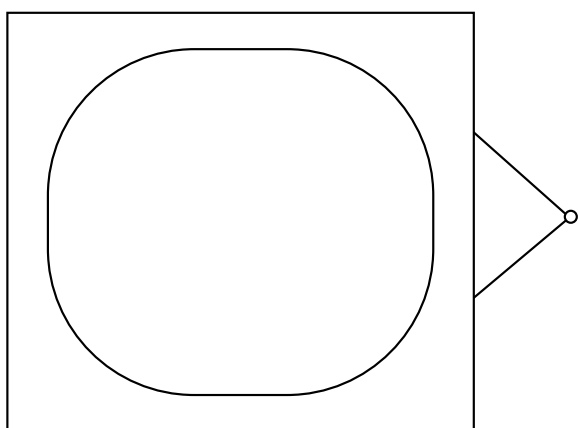
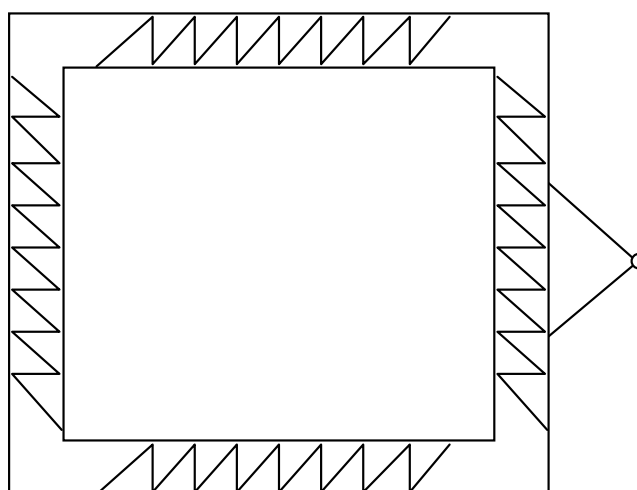
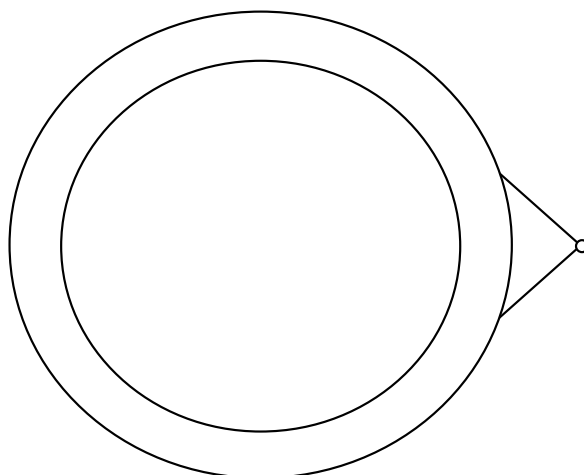
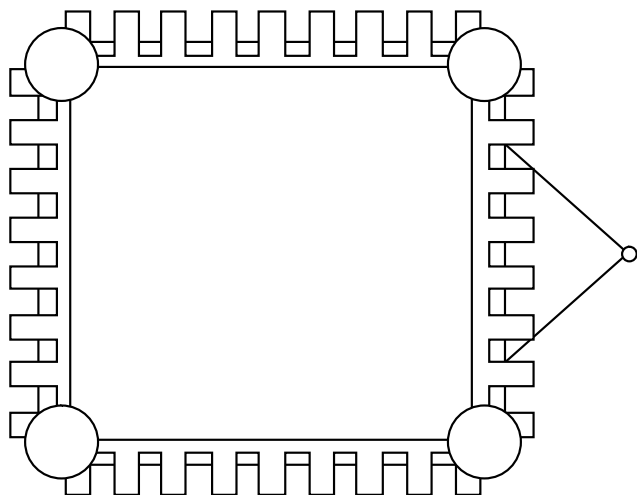

Kto huśta się na huśtawce? Narysuj tę postać.

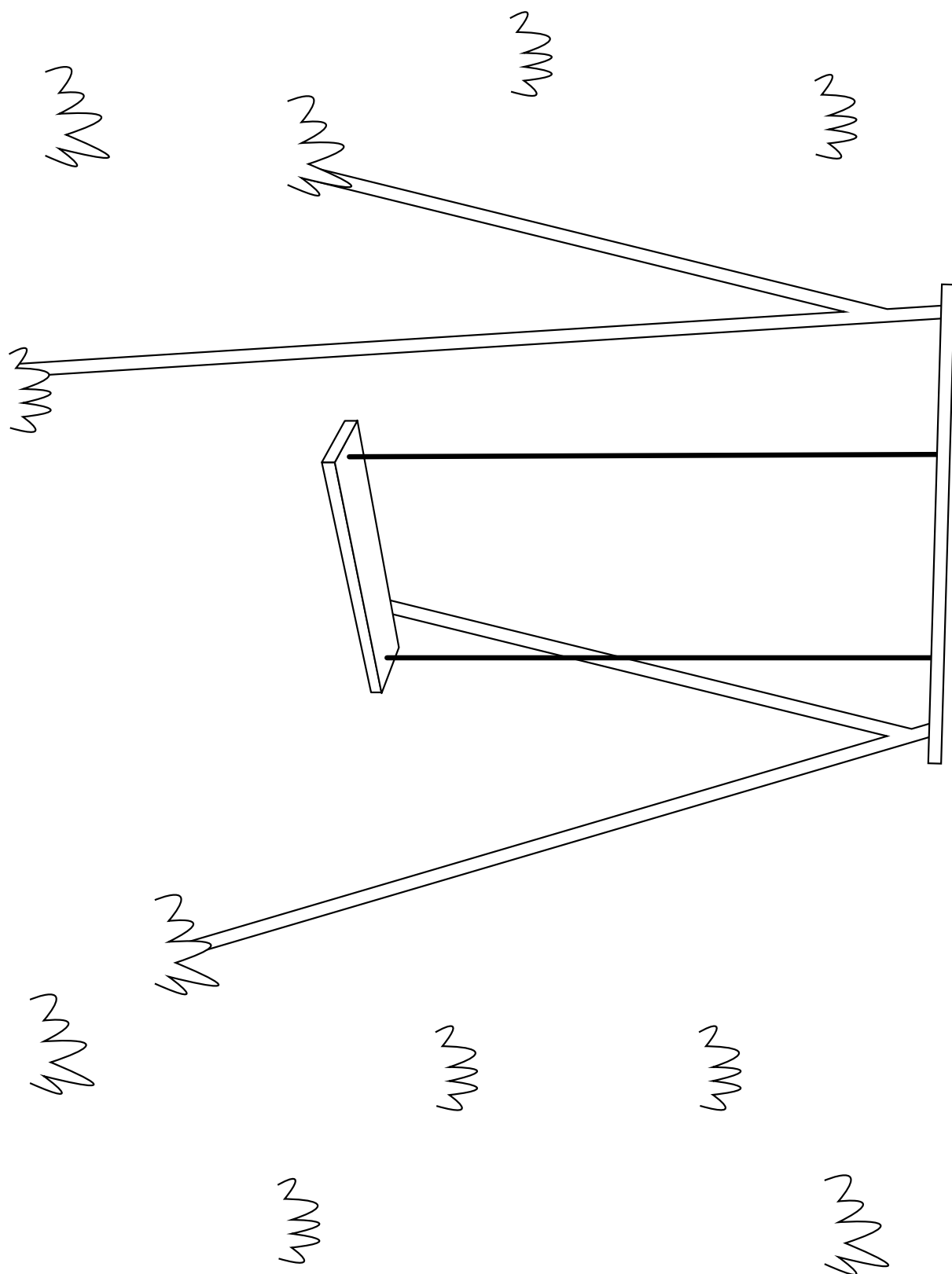

Co wyrosło w ogródku? Narysuj to.

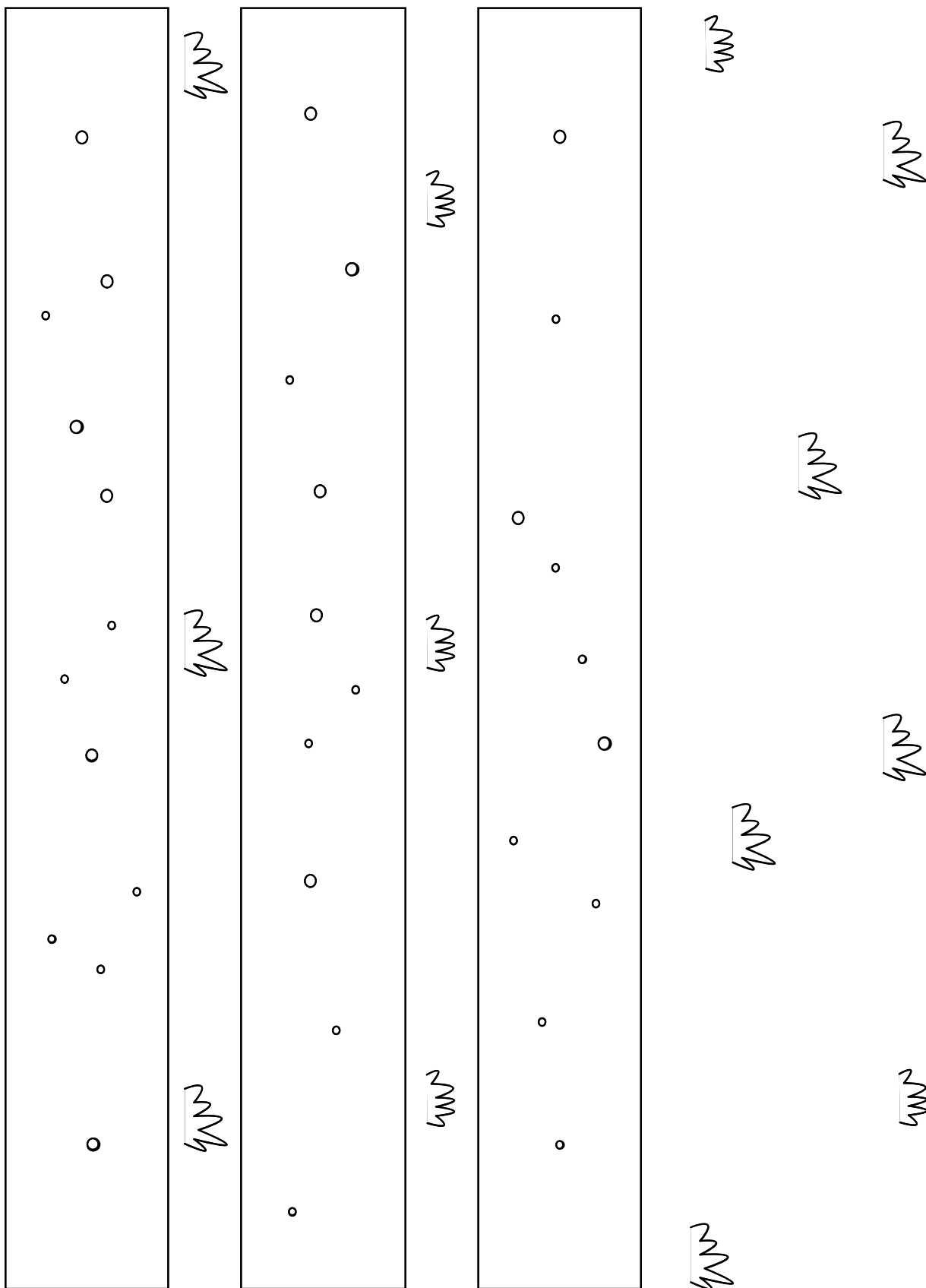

Którędy jechało auto? Zaznacz trasę przejazdu na rysunku.

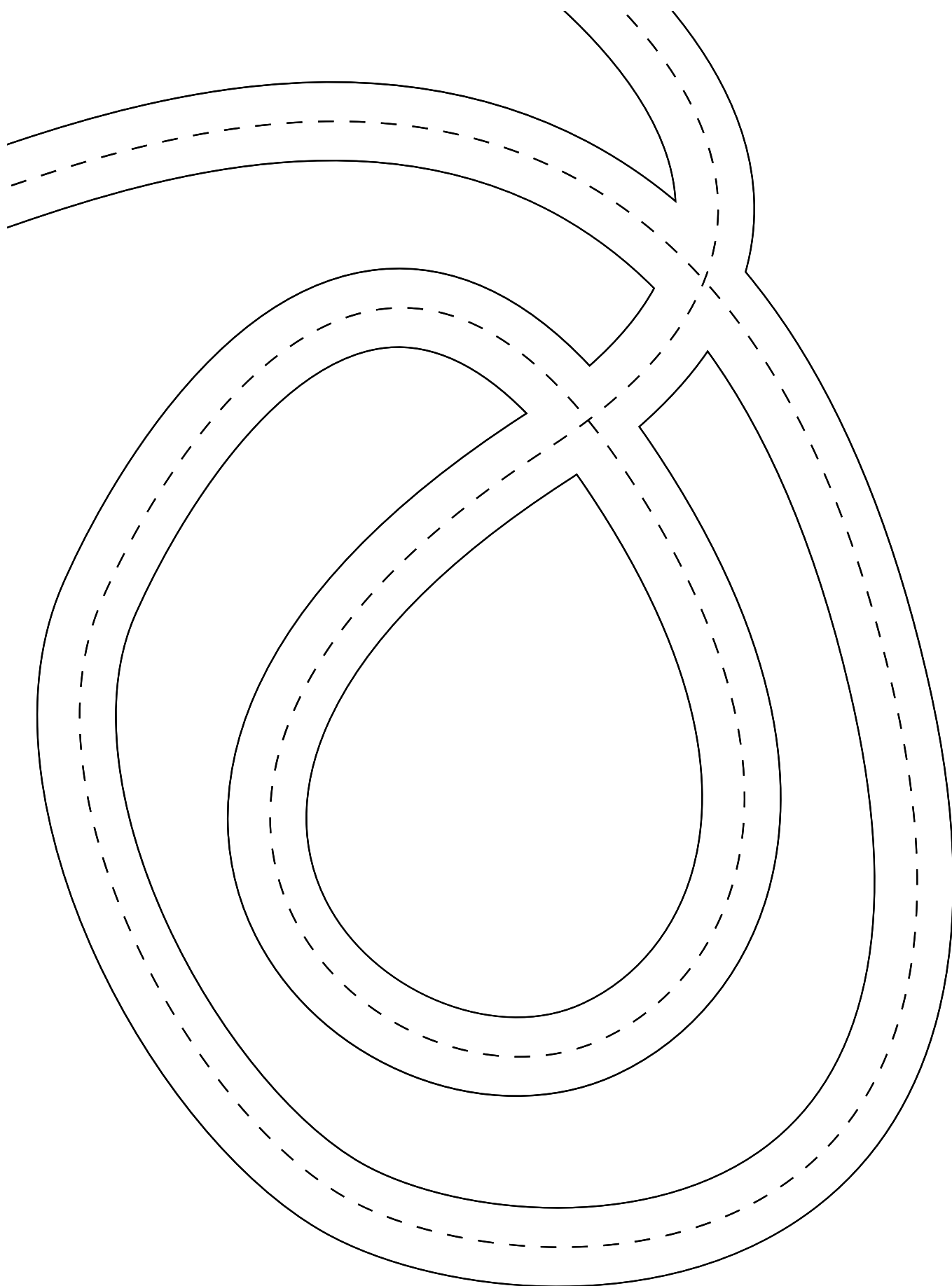

Kto przyleciał tym UFO? Narysuj tę postać.

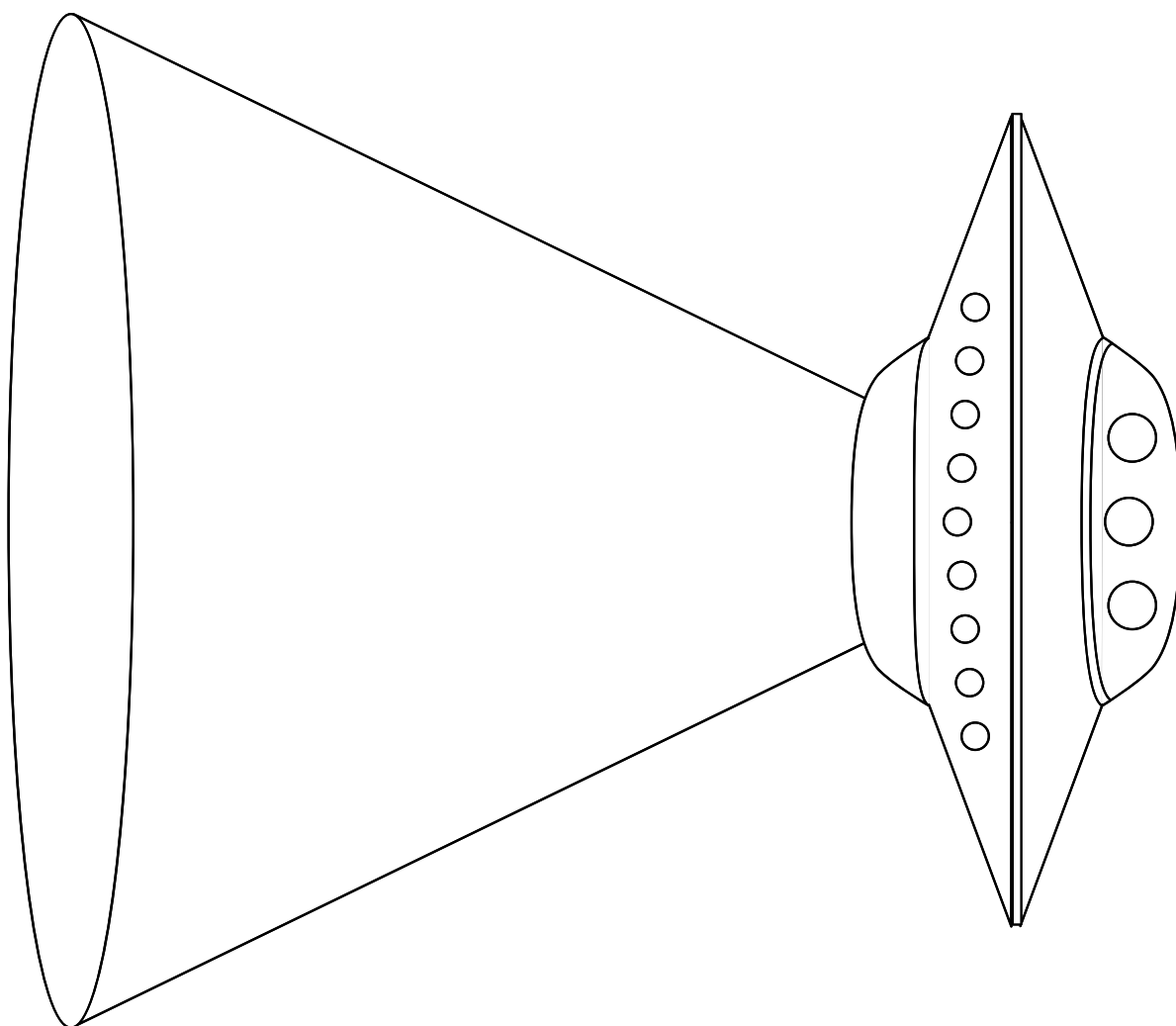

Czym przyleciał ten ufoludek na Ziemię? Dokończ rysunek.

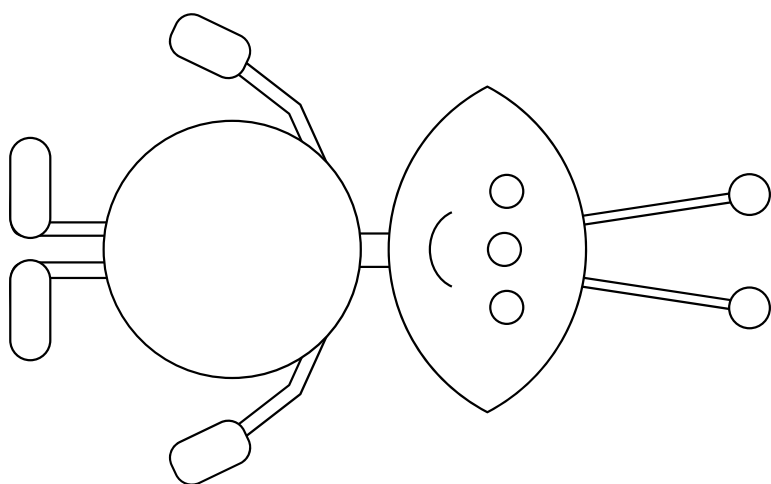

Ubierz postacie stosownie do pogody za oknem.

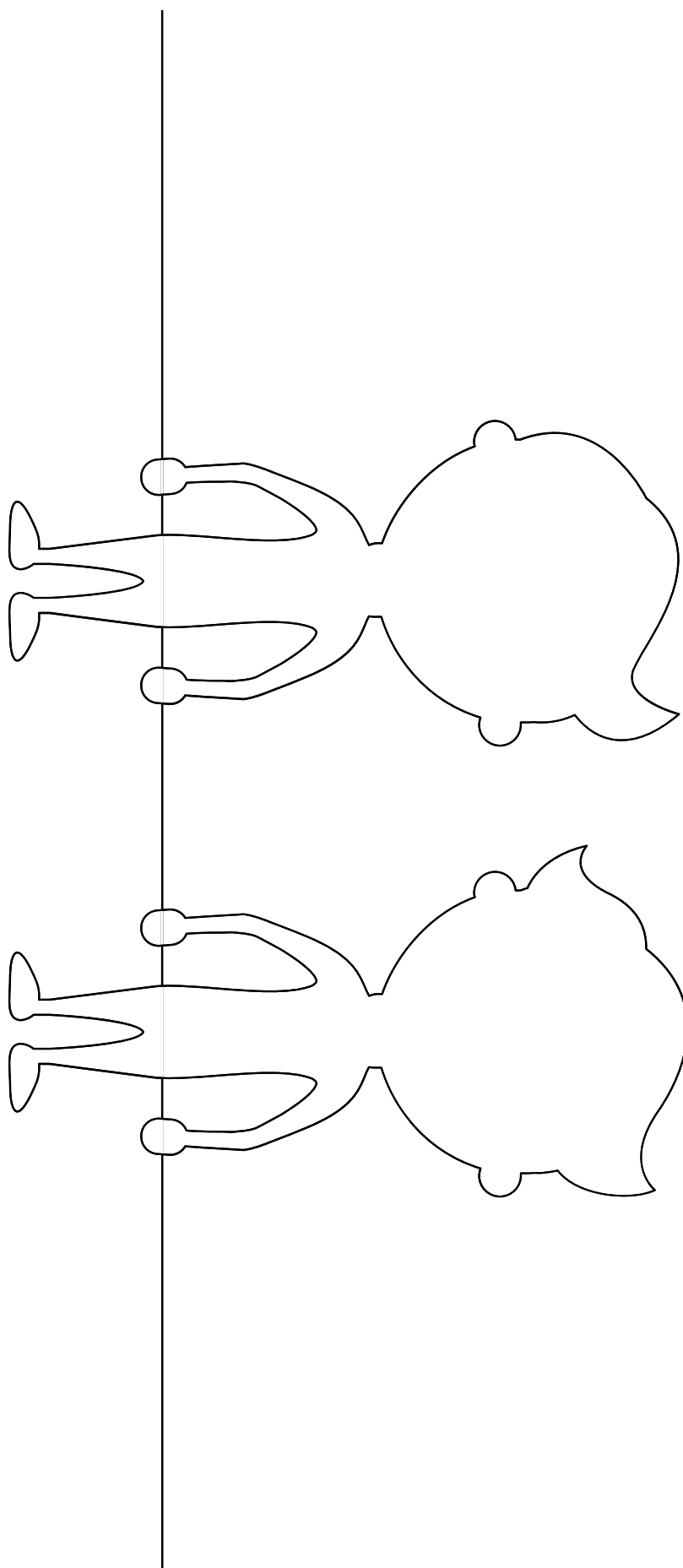

Zaprojektuj swój T-shirt.

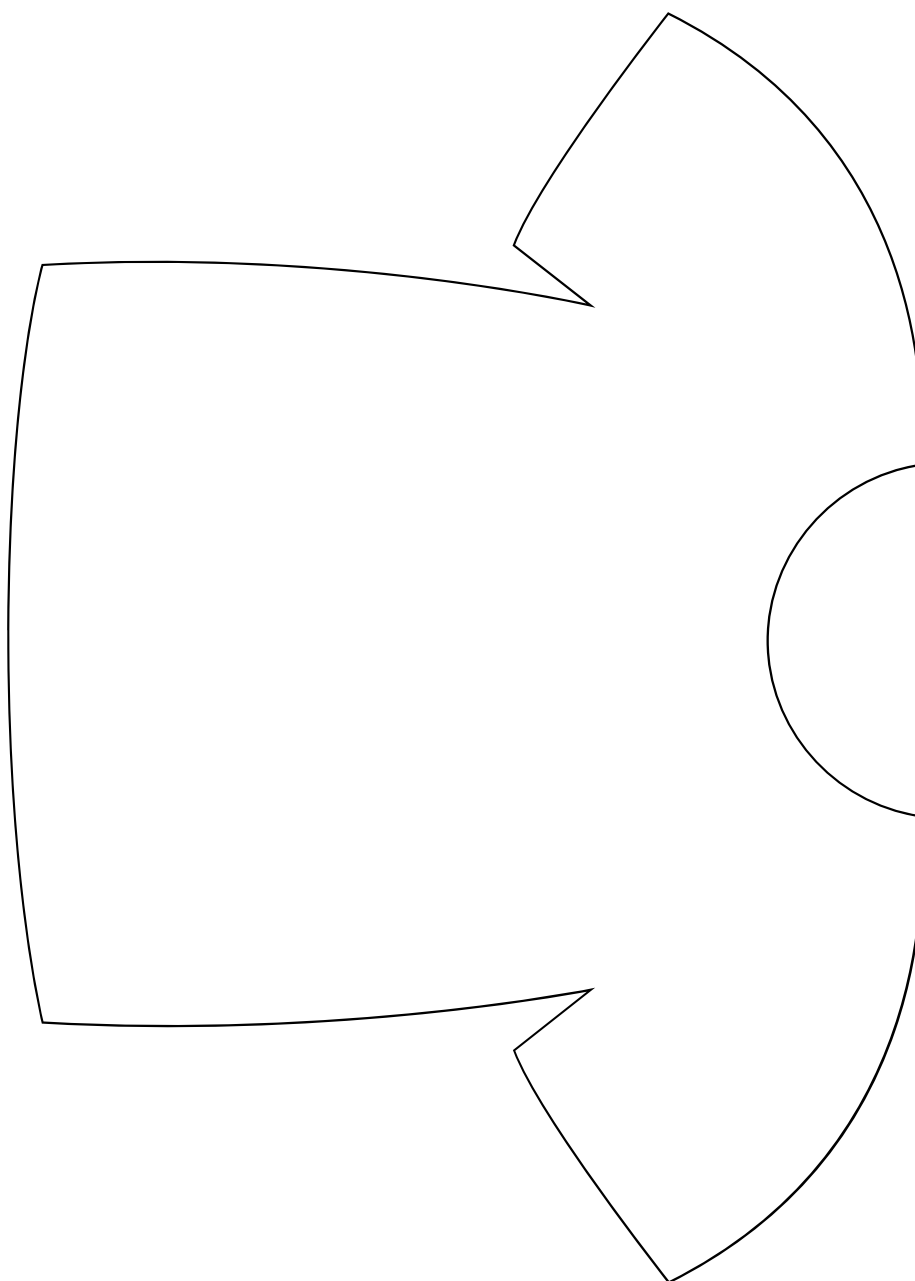

Kto wyskoczył z magicznego kapelusza? Narysuj tę postać.

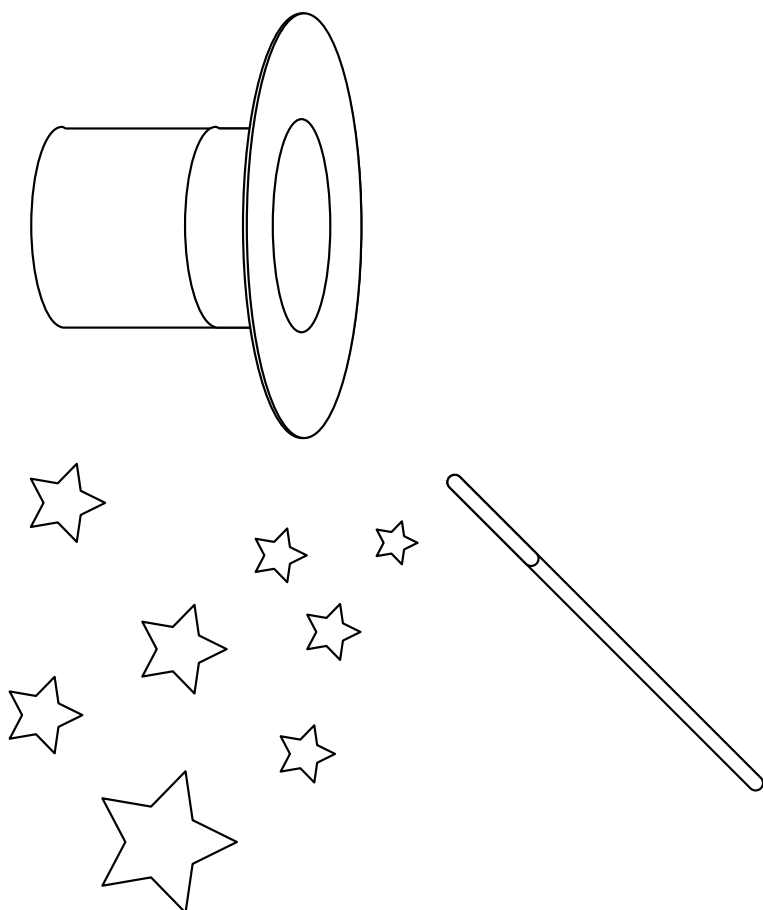



SMART
FLOOR

W KRAINIE KOLORÓW

Dowiedz się więcej o pakiecie w sklepie z aplikacjami Motioncube

store.motioncube.io

Projekt i opracowanie: ©LavaVision